

# DENON

AV SURROUND RECEIVER

# AVR-1909

---

Owner's Manual

Manuel de l'Utilisateur

SAFETY PRECAUTIONS



**CAUTION**

**RISK OF ELECTRIC SHOCK**

**DO NOT OPEN**



**CAUTION:**  
**TO REDUCE THE RISK OF ELECTRIC SHOCK, DO NOT REMOVE COVER (OR BACK). NO USER-SERVICEABLE PARTS INSIDE. REFER SERVICING TO QUALIFIED SERVICE PERSONNEL.**

The lightning flash with arrowhead symbol, within an equilateral triangle, is intended to alert the user to the presence of uninsulated "dangerous voltage" within the product's enclosure that may be of sufficient magnitude to constitute a risk of electric shock to persons.

The exclamation point within an equilateral triangle is intended to alert the user to the presence of important operating and maintenance (servicing) instructions in the literature accompanying the appliance.

**WARNING:**  
**TO REDUCE THE RISK OF FIRE OR ELECTRIC SHOCK, DO NOT EXPOSE THIS APPLIANCE TO RAIN OR MOISTURE.**

# SAFETY INSTRUCTIONS

1. Read Instructions – All the safety and operating instructions should be read before the product is operated.
2. Retain Instructions – The safety and operating instructions should be retained for future reference.
3. Heed Warnings – All warnings on the product and in the operating instructions should be adhered to.
4. Follow Instructions – All operating and use instructions should be followed.
5. Cleaning – Unplug this product from the wall outlet before cleaning. Do not use liquid cleaners or aerosol cleaners.
6. Attachments – Do not use attachments not recommended by the product manufacturer as they may cause hazards.
7. Water and Moisture – Do not use this product near water – for example, near a bath tub, wash bowl, kitchen sink, or laundry tub; in a wet basement; or near a swimming pool; and the like.
8. Accessories – Do not place this product on an unstable cart, stand, tripod, bracket, or table. The product may fall, causing serious injury to a child or adult, and serious damage to the product. Use only with a cart, stand, tripod, bracket, or table recommended by the manufacturer, or sold with the product. Any mounting of the product should follow the manufacturer's instructions, and should use a mounting accessory recommended by the manufacturer.
9. A product and cart combination should be moved with care. Quick stops, excessive force, and uneven surfaces may cause the product and cart combination to overturn.
10. Ventilation – Slots and openings in the cabinet are provided for ventilation and to ensure reliable operation of the product and to protect it from overheating, and these openings must not be blocked or covered. The openings should never be blocked by placing the product on a bed, sofa, rug, or other similar surface. This product should not be placed in a built-in installation such as a bookcase or rack unless proper ventilation is provided or the manufacturer's instructions have been adhered to.
11. Power Sources – This product should be operated only from the type of power source indicated on the marking label. If you are not sure of the type of power supply to your home, consult your product dealer or local power company. For products intended to operate from battery power, or other sources, refer to the operating instructions.
12. Grounding or Polarization – This product may be equipped with a polarized alternating-current line plug (a plug having one blade wider than the other). This plug will fit into the power outlet only one way. This is a safety feature. If you are unable to insert the plug fully into the outlet, try reversing the plug. If the plug should still fail to fit, contact your electrician to replace your obsolete outlet. Do not defeat the safety purpose of the polarized plug.
13. Power-Cord Protection – Power-supply cords should be routed so that they are not likely to be walked on or pinched by items placed upon or against them, paying particular attention to cords at plugs, convenience receptacles, and the point where they exit from the product.
15. Outdoor Antenna Grounding – If an outside antenna or cable system is connected to the product, be sure the antenna or cable system is grounded so as to provide some protection against voltage surges and built-up static charges. Article 810 of the National Electrical Code, ANSI/NFPA 70, provides information with regard to proper grounding of the mast and supporting structure, grounding of the lead-in wire to an antenna discharge unit, size of grounding conductors, location of antenna-discharge unit, connection to grounding electrodes, and requirements for the grounding electrode. See Figure A.
16. Lightning – For added protection for this product during a lightning storm, or when it is left unattended and unused for long periods of time, unplug it from the wall outlet and disconnect the antenna or cable system. This will prevent damage to the product due to lightning and power-line surges.
17. Power Lines – An outside antenna system should not be located in the vicinity of overhead power lines or other electric light or power circuits, or where it can fall into such power lines or circuits. When installing an outside antenna system, extreme care should be taken to keep from touching such power lines or circuits as contact with them might be fatal.
18. Overloading – Do not overload wall outlets, extension cords, or integral convenience receptacles as this can result in a risk of fire or electric shock.
19. Object and Liquid Entry – Never push objects of any kind into this product through openings as they may touch dangerous voltage points or short-out parts that could result in a fire or electric shock. Never spill liquid of any kind on the product.
20. Servicing – Do not attempt to service this product yourself as opening or removing covers may expose you to dangerous voltage or other hazards. Refer all servicing to qualified service personnel.
21. Damage Requiring Service – Unplug this product from the wall outlet and refer servicing to qualified service personnel under the following conditions:
  - a) When the power-supply cord or plug is damaged,
  - b) If liquid has been spilled, or objects have fallen into the product,
  - c) If the product has been exposed to rain or water,
  - d) If the product does not operate normally by following the operating instructions. Adjust only those controls that are covered by the operating instructions as an improper adjustment of other controls may result in damage and will often require extensive work by a qualified technician to restore the product to its normal operation,
  - e) If the product has been dropped or damaged in any way, and
  - f) When the product exhibits a distinct change in performance – this indicates a need for service.
22. Replacement Parts – When replacement parts are required, be sure the service technician has used replacement parts specified by the manufacturer or have the same characteristics as the original part. Unauthorized substitutions may result in fire, electric shock, or other hazards.
23. Safety Check – Upon completion of any service or repairs to this product, ask the service technician to perform safety checks to determine that the product is in proper operating condition.
24. Wall or Ceiling Mounting – The product should be mounted to a wall or ceiling only as recommended by the manufacturer.
25. Heat – The product should be situated away from heat sources such as radiators, heat registers, stoves, or other products (including amplifiers) that produce heat.

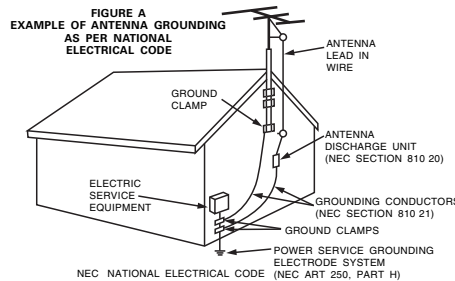

### FCC INFORMATION (For US customers)

#### 1. PRODUCT

This product complies with Part 15 of the FCC Rules. Operation is subject to the following two conditions: (1) this product may not cause harmful interference, and (2) this product must accept any interference received, including interference that may cause undesired operation.

#### 2. IMPORTANT NOTICE: DO NOT MODIFY THIS PRODUCT

This product, when installed as indicated in the instructions contained in this manual, meets FCC requirements. Modification not expressly approved by DENON may void your authority, granted by the FCC, to use the product.

#### 3. NOTE

This product has been tested and found to comply with the limits for a Class B digital device, pursuant to Part 15 of the FCC Rules. These limits are designed to provide reasonable protection against harmful interference in a residential installation.

This product generates, uses and can radiate radio frequency energy and, if not installed and used in accordance with the instructions, may cause harmful interference to radio communications. However, there is no guarantee that interference will not occur in a particular installation. If this product does cause harmful interference to radio or television reception, which can be determined by turning the product OFF and ON, the user is encouraged to try to correct the interference by one or more of the following measures:

- Reorient or relocate the receiving antenna.
- Increase the separation between the equipment and receiver.
- Connect the product into an outlet on a circuit different from that to which the receiver is connected.
- Consult the local retailer authorized to distribute this type of product or an experienced radio/TV technician for help.

This Class B digital apparatus complies with Canadian ICES-003.  
Cet appareil numérique de la classe B est conforme à la norme NMB-003 du Canada.

### NOTE ON USE / OBSERVATIONS RELATIVES A L'UTILISATION



- Avoid high temperatures. Allow for sufficient heat dispersion when installed in a rack.
- Eviter des températures élevées. Tenir compte d'une dispersion de chaleur suffisante lors de l'installation sur une étagère.



- Keep the unit free from moisture, water, and dust.
- Protéger l'appareil contre l'humidité, l'eau et la poussière.



- Do not let foreign objects into the unit.
- Ne pas laisser des objets étrangers dans l'appareil.

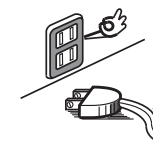

- Unplug the power cord when not using the unit for long periods of time.
- Débrancher le cordon d'alimentation lorsque l'appareil n'est pas utilisé pendant de longues périodes.

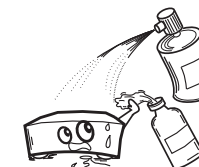

- Do not let insecticides, benzene, and thinner come in contact with the unit.
- Ne pas mettre en contact des insecticides, du benzène et un diluant avec l'appareil.

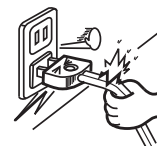

- Handle the power cord carefully. Hold the plug when unplugging the cord.
- Manipuler le cordon d'alimentation avec précaution. Tenir la prise lors du débranchement du cordon.



\* (For apparatuses with ventilation holes)

- Do not obstruct the ventilation holes.
- Ne pas obstruer les trous d'aération.



- Never disassemble or modify the unit in any way.
- Ne jamais démonter ou modifier l'appareil d'une manière ou d'une autre.

## □ Contents

### Getting Started

Accessories .....	2
Cautions on Handling .....	3
Cautions on Installation .....	3
About the Remote Control Unit .....	3
Inserting the Batteries .....	3
Operating Range of the Remote Control Unit .....	3
Part Names and Functions .....	4
Front Panel .....	4
Display .....	5
Rear Panel .....	6
Remote Control Unit .....	7

### Connections

Preparations .....	8
Cables Used for Connections .....	8
Video Conversion Function .....	9
On-Screen Display for Component Video Outputs and HDMI Output .....	9
Speaker Connections .....	10
Speaker Installation .....	10
Speaker Connections .....	10
Connecting Equipment with HDMI connectors .....	12
Connecting the Monitor .....	13
Connecting the Playback Components .....	13
Blu-ray Disc player / DVD player .....	13
CD Player .....	14
iPod® .....	14
TV/CABLE Tuner .....	15
Connecting the Recording Components .....	15
Video Cassette Recorder .....	15
CD Recorder / MD Recorder / Tape Deck .....	16
Connections to Other Devices .....	16
Video Camera / Game Console .....	16
Component with Multi-channel Output connectors .....	17
XM connector .....	17
SIRIUS connector .....	18
Antenna terminals .....	19
Multi-zone .....	20
External Controller .....	20
Connecting the Power Cord .....	21
Once Connections are Completed .....	21

### Menu Operations

Operations .....	22
Example of Display of Default Values .....	22
Examples of On-screen Display and Front Display .....	23
Menu Map .....	24

### Auto Setup

Preparations .....	25
Auto Setup .....	26
1 Start Menu .....	26
Error Messages .....	28
2 Parameter Check .....	29

### Manual Setup

Speaker Setup .....	29
1 Speaker Configuration .....	29
2 Subwoofer Setup .....	30
3 Distance .....	30
4 Channel Level .....	31
5 Crossover Frequency .....	31
6 Front Speaker Setup .....	31
HDMI Setup .....	32
1 Color Space .....	32
2 RGB Range .....	32
3 Auto Lipsync .....	32
4 HDMI Audio Out .....	32
5 HDMI Control .....	32
6 Power Off Control .....	32
Audio Setup .....	33
1 EXT. IN Subwoofer Level .....	33
2 2ch Direct/Stereo .....	33
3 Dolby Digital Setup .....	33
4 Auto Surround Mode .....	33
5 EQ Preset .....	34
ZONE2 Setup .....	34
1 Level Lch .....	34
2 Level Rch .....	34
3 Volume Limit .....	35
4 Power On Level .....	35
5 Mute Level .....	35

Option Setup .....	35
1 Amp Assign .....	35
2 Volume Control .....	35
3 Source Delete .....	36
4 On-Screen Display .....	36
5 Quick Select Name .....	36
6 Remote ID Setup .....	36
7 2Way Remote .....	36
8 Display .....	37
9 Setup Lock .....	37

### Input Setup

Settings Related to Playing Input Sources .....	39
1 Auto Preset .....	39
2 Preset Skip .....	39
3 Preset Name .....	39
4 Video .....	39
5 Input Mode .....	41
6 Rename .....	41
7 Source Level .....	41
8 Assign .....	42
9 iPod .....	42
10 Antenna Aiming .....	43
11 Parental Lock .....	43

### Surround Modes

① Standard Playback .....	44
Surround Playback of 2-channel Sources .....	44
Playing Multi-channel Sources (Dolby Digital, DTS, etc.) .....	45
② DSP Simulation Playback .....	45
③ Direct Playback .....	45
④ Stereo Playback .....	45
Playback in the PURE DIRECT Mode .....	46

### Parameter

Adjusting the parameters .....	46
Surround Parameter .....	47
Surround Parameter .....	47
Tone .....	49
Audyssey Settings .....	49
RESTORER .....	51
Night Mode .....	51
Audio Delay .....	51

**Information**

**Status** ..... 52  
**1** MAIN ZONE ..... 52  
**2** ZONE2 ..... 52  
**Audio Input Signal** ..... 52  
**HDMI Information** ..... 53  
**1** HDMI Signal Information ..... 53  
**2** HDMI Monitor Information ..... 53  
**Auto Surround Mode** ..... 53  
**Quick Select** ..... 53  
**Preset Station** ..... 53

**Playback**

**Preparations** ..... 54  
 Turning the Power On ..... 54  
 Selecting the Input Source ..... 54  
 Operations During Playback ..... 54  
**Playing Video and Audio Equipment** ..... 55  
 Basic Operation ..... 55  
**Listening to FM/AM Broadcasts** ..... 55  
 Basic Operation ..... 55  
 Presetting Radio Stations (Preset Memory) ..... 55  
 Listening to Preset Stations ..... 56  
**Listening to XM Satellite Radio Programs** ..... 56  
 Basic Operation ..... 56  
 Checking the XM Signal Strength and Radio ID ..... 56  
 Presetting Radio Stations (Preset Memory) ..... 57  
 Listening to Preset Stations ..... 57  
 Searching Categories ..... 57  
**Listening to SIRIUS Satellite Radio Programs** ..... 57  
 Basic Operation ..... 58  
 Checking the SIRIUS Signal Strength and Radio ID ..... 58  
 Presetting Radio Stations (Preset Memory) ..... 58  
 Listening to Preset Stations ..... 58  
 Searching Categories ..... 59  
 Parental Lock ..... 59  
**iPod® Playback** ..... 59  
 Basic Operation ..... 59  
 Listening to Music ..... 60  
 Viewing Still Pictures or Videos on the iPod ..... 60

**Other Operations and Functions**

**Other Operations** ..... 61  
 Recording on an External Equipment (REC OUT mode) ..... 61  
**Convenient Functions** ..... 62  
 HDMI Control Function ..... 62  
 Channel Level ..... 63  
 Fader Function ..... 63  
 Quick Select Function ..... 64  
 Personal Memory Plus Function ..... 64  
 Last Function Memory ..... 64  
 Backup Memory ..... 64  
 Resetting the Microprocessor ..... 64

**Remote Control Unit Operations**

**Main Remote Control Unit (RC-1099)** ..... 65  
 Operating DENON Audio Components ..... 65  
 Presetting ..... 65  
 Operating Preset Components ..... 65  
 Punch Through Function ..... 68  
**Sub Remote Control Unit (RC-1107)** ..... 68

**Amp Assign / Multi-zone Connections and Operations**

**Multi-zone Settings with the Amp Assign Function** ..... 69  
**Multi-zone Settings and Operations with Zone Output** ..... 71  
**Multi-zone Operations** ..... 72  
 Turning the Power On and Off ..... 72  
 Selecting the Input Source ..... 72  
 Adjusting the Volume ..... 72  
 Turning off the Sound Temporarily ..... 72

**Other Information** ..... 73

**Troubleshooting** ..... 82

**Specifications** ..... 86

**List of preset codes** ..... End of this manual

**Getting Started**

Thank you for purchasing this DENON product. To ensure proper operation, please read this owner's manual carefully before using the product.

After reading them, be sure to keep them for future reference.

**Accessories**

Check that the following parts are supplied with the product.

- ① Owner's manual ..... 1
- ② Getting Started ..... 1
- ③ Warranty (for North America model only) ..... 1
- ④ Service station list ..... 1
- ⑤ Main remote control (RC-1099) ..... 1
- ⑥ R6/AA batteries (for RC-1099) ..... 2
- ⑦ Sub remote control (RC-1107) ..... 1
- ⑧ R03/AAA batteries (for RC-1107) ..... 2
- ⑨ FM indoor antenna ..... 1
- ⑩ AM loop antenna ..... 1
- ⑪ Setup microphone (DM-A409, Cord length: Approx. 25 ft / 7.6 m) ..... 1

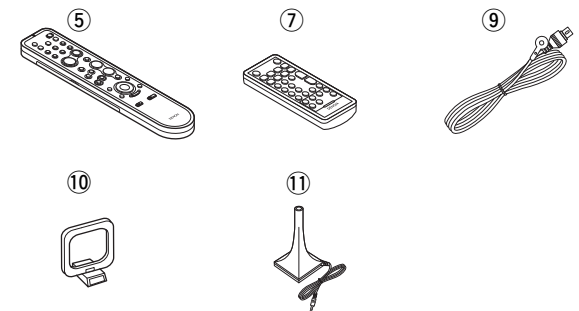

## Cautions on Handling

### • Before turning the power switch on

Check once again that all connections are correct and that there are no problems with the connection cables.

- Power is supplied to some of the circuitry even when the unit is set to the standby mode. When traveling or leaving home for long periods of time, be sure to unplug the power cord from the power outlet.

### • About condensation

If there is a major difference in temperature between the inside of the unit and the surroundings, condensation (dew) may form on the operating parts inside the unit, causing the unit not to operate properly.

If this happens, let the unit sit for an hour or two with the power turned off and wait until there is little difference in temperature before using the unit.

### • Cautions on using mobile phones

Using a mobile phone near this unit may result in noise. If so, move the mobile phone away from this unit when it is in use.

### • Moving the unit

Turn off the power and unplug the power cord from the power outlet.

Next, disconnect the connection cables to other system units before moving the unit.

- Note that the illustrations in these instructions may differ from the actual unit for explanation purposes.

## Cautions on Installation

### Note:

For proper heat dispersal, do not install this unit in a confined space, such as a bookcase or similar enclosure.

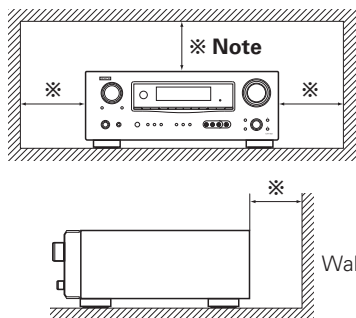

## About the Remote Control Unit

In addition to the AVR-1909, the included main remote control unit (RC-1099) can also be used to operate the equipment listed below.

- ① DENON system components
- ② Non-DENON system components
  - By setting the preset memory (page 65 ~ 67)

### Inserting the Batteries

- ① Lift the clasp and remove the rear lid.

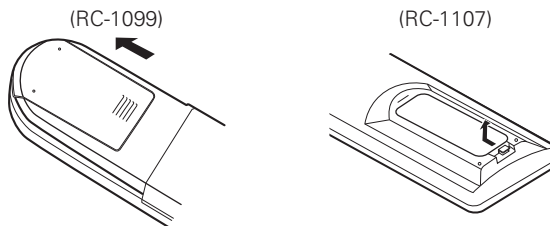

- ② Load the two batteries properly as indicated by the marks in the battery compartment.

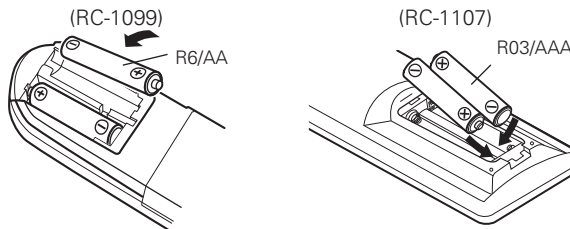

- ③ Put the rear cover back on.

### NOTE

- Replace the batteries with new ones if the set does not operate even when the remote control unit is operated close to the unit.
- The supplied batteries are only for verifying operation.
- When inserting the batteries, be sure to do so in the proper direction, following the “⊕” and “⊖” marks in the battery compartment.
- To prevent damage or leakage of battery fluid:
  - Do not use a new battery together with an old one.
  - Do not use two different types of batteries.
  - Do not attempt to charge dry batteries.
  - Do not short-circuit, disassemble, heat or dispose of batteries in flames.
- If the battery fluid should leak, carefully wipe the fluid off the inside of the battery compartment and insert new batteries.
- Remove the batteries from the remote control unit if it will not be in use for long periods.
- When replacing the batteries, have the new batteries ready and insert them as quickly as possible.

### Operating Range of the Remote Control Unit

Point the remote control unit at the remote sensor when operating it.

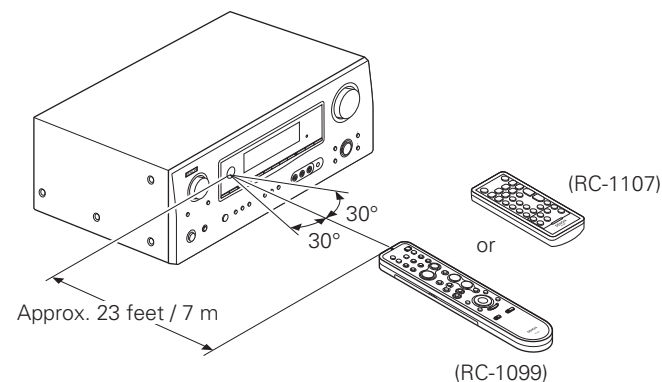

### NOTE

The set may function improperly or the remote control unit may not operate if the remote control sensor is exposed to direct sunlight, strong artificial light from an inverter type fluorescent lamp or infrared light.

# Part Names and Functions

For buttons not explained here, see the page indicated in parentheses ( ).

## Front Panel

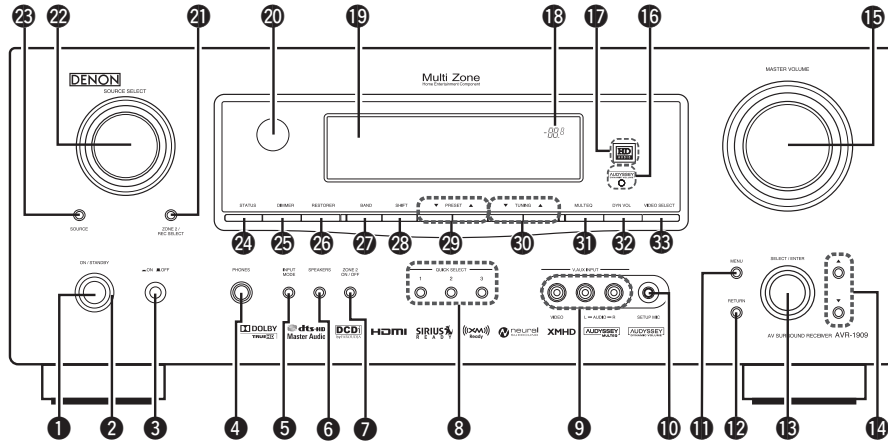

- 1 Power operation button (ON/STANDBY) ..... (54)
- 2 Power indicator ..... (54)
- 3 Power switch (ON/OFF) ..... (54)
- 4 Headphones jack (PHONES) ..... (54)
- 5 INPUT MODE button ..... (17, 41)
- 6 SPEAKERS button ..... (31, 54)
- 7 ZONE2 ON/OFF button ..... (72)
- 8 QUICK SELECT buttons ..... (64)
- 9 V. AUX INPUT connectors

Remove the cap covering the terminals when you want to use them.

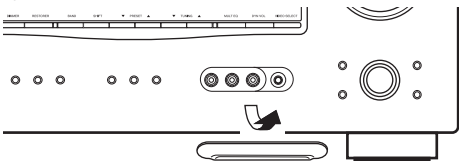

- 10 SETUP MIC jack ..... (25)
- 11 MENU button ..... (22)
- 12 RETURN button ..... (22)
- 13 SELECT/ENTER knob ..... (22)



• The **SELECT/ENTER** knob on the main unit operates in the same way as the cursor  $\triangleleft$  and  $\triangleright$  buttons on the remote control unit.



- The control functions in the same way as the cursor  $\triangleleft$  button when turned counterclockwise, as the cursor  $\triangleright$  button when turned clockwise.
- The control functions in the same way as the **ENTER** button when pressed the knob.

- 14 Cursor buttons ( $\triangle$   $\nabla$ ) ..... (22)
  - 15 MASTER VOLUME control knob ..... (54)
  - 16 AUDYSSEY DYNAMIC VOLUME indicator ..... (50)
  - 17 HD AUDIO indicator ..... (45)
  - 18 Master volume indicator
  - 19 Display
  - 20 Remote control sensor ..... (3)
  - 21 ZONE2/REC SELECT button ..... (72)
  - 22 SOURCE SELECT knob ..... (54)
  - 23 SOURCE button ..... (54)
  - 24 STATUS button ..... (52, 56)
  - 25 DIMMER button ..... (37)
  - 26 RESTORER button ..... (51)
  - 27 BAND button ..... (55)
  - 28 SHIFT button ..... (55)
  - 29 PRESET buttons ..... (55)
  - 30 TUNING buttons ..... (55)
  - 31 MULTEQ button ..... (49)
  - 32 DYNAMIC VOLUME button ..... (50)
  - ※ About Dynamic Volume
- Audyssey Dynamic Volume™ solves the problem of large variations in volume level between television programs, commercials, and between the soft and loud passages of movies. Audyssey Dynamic EQ™ is integrated into Dynamic Volume so that as the playback volume is adjusted automatically, the perceived bass response, tonal balance, surround impression, and dialog clarity remain the same.
- ※ About Dynamic EQ
- Audyssey Dynamic EQ solves the problem of deteriorating sound quality as volume is decreased by taking into account human perception and room acoustics. Audyssey Dynamic EQ works in tandem with Audyssey MultEQ® to provide well-balanced sound for every listener at any volume level.
- 33 VIDEO SELECT button ..... (39)



# Display

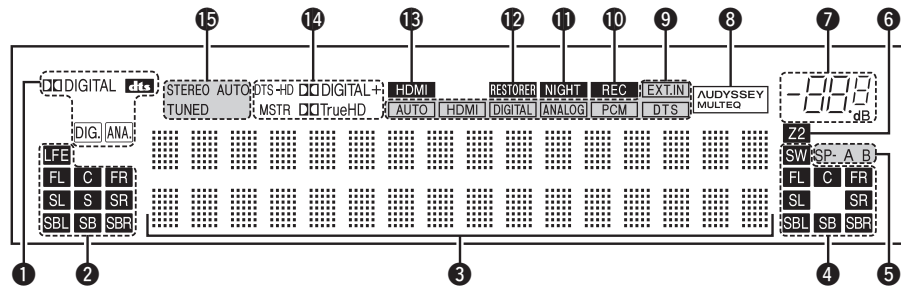

- 1 Input signal indicators**
- 2 Input signal channel indicators**  
These light when digital signals are input.
- 3 Information display**  
The input source name, surround mode, setting values and other information are displayed here.
- 4 Output signal channel indicators**
- 5 Front speaker indicator**  
These light according to the settings of the front A and B speakers.
- 6 ZONE2 output indicator**  
This lights when the power for the ZONE2 is turned on.
- 7 Master volume indicator**
- 8 AUDYSSEY MULTEQ indicator**  
This lights when the MultEQ is selected.
- 9 Input mode indicators**
- 10 Recording output source indicator**  
This lights when the REC OUT mode is selected.
- 11 NIGHT indicator**  
This lights when the night mode is selected.
- 12 RESTORER indicator**  
This lights when the RESTORER mode is selected.
- 13 HDMI indicator**  
This lights when playing using HDMI connections.
- 14 Decoder indicators**  
These light when the respective decoders are operating.
- 15 Tuner reception mode indicators**  
This lights according to the reception conditions when the input source is set to "TUNER".
  - **AUTO**  
This lights when in the auto tuning mode.
  - **STEREO**  
In the FM mode, this lights when receiving analog stereo broadcasts.
  - **TUNED**  
This lights when the broadcast is properly tuned in.



Rear Panel

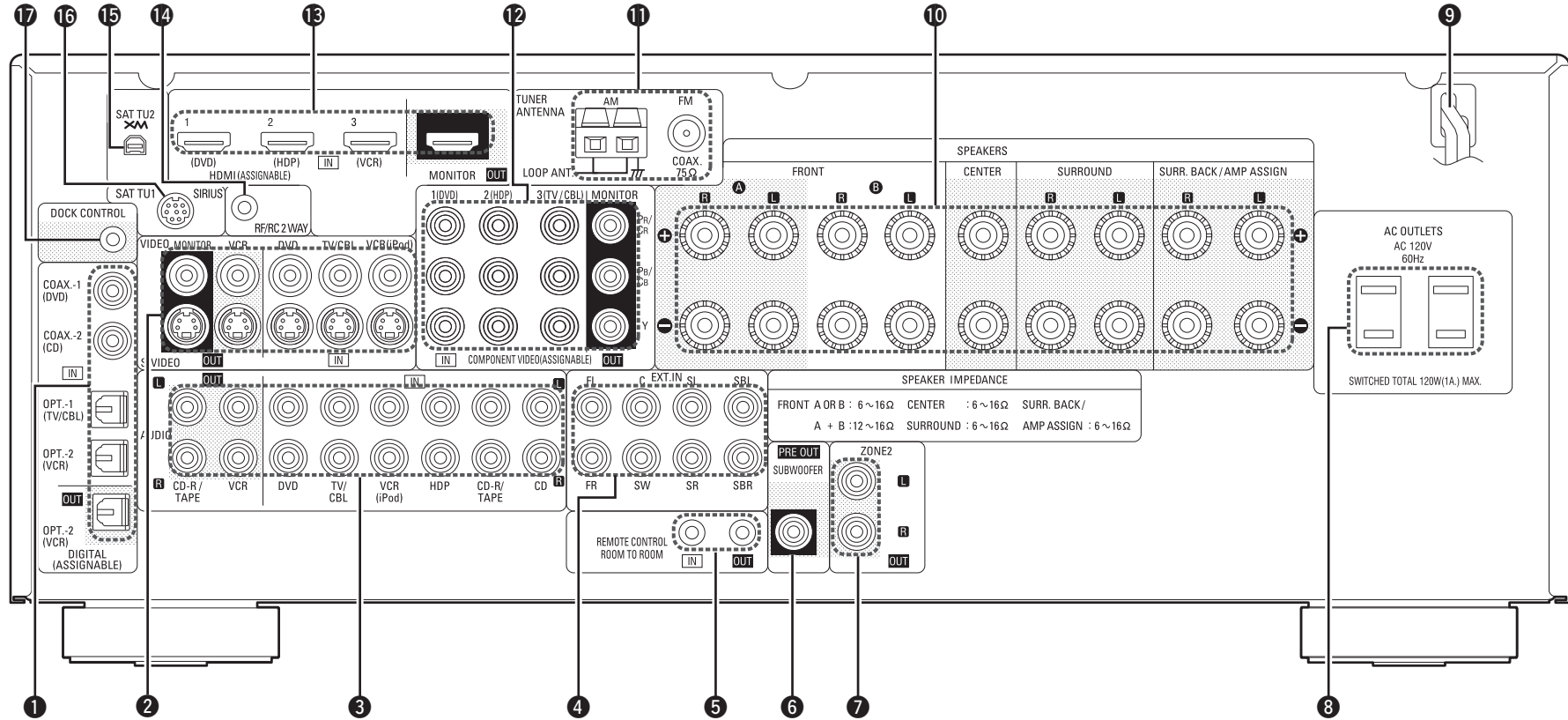

- ① Digital audio connectors (OPTICAL / COAXIAL) ..... (13 ~ 15, 18)
- ② VIDEO / S-VIDEO connectors ..... (13 ~ 16)
- ③ Analog audio connectors (AUDIO) ... (13 ~ 16)
- ④ EXT. IN connectors ..... (17)
- ⑤ REMOTE CONTROL jacks ..... (20)
- ⑥ PRE OUT connector ..... (10)
- ⑦ ZONE2 connectors ..... (20)
- ⑧ AC OUTLETS ..... (21)
- ⑨ Power cord ..... (21)
- ⑩ Speaker terminals (SPEAKERS) ..... (10)
- ⑪ FM/AM antenna terminals (TUNER ANTENNA) ..... (19)
- ⑫ COMPONENT VIDEO connectors ..... (13, 15)
- ⑬ HDMI connectors ..... (12, 13, 15)
- ⑭ RF/RC 2 WAY jack ..... (20)
- ⑮ XM connector (SAT TU2) ..... (17)
- ⑯ SIRIUS connector (SAT TU1) ..... (18)
- ⑰ DOCK CONTROL jack ..... (14)

Getting Started  
Connections  
Setup  
Playback  
Remote Control  
Multi-zone  
Information  
Troubleshooting  
Specifications

# Remote Control Unit

## □ Main Remote Control Unit (RC-1099)

[ Front ]

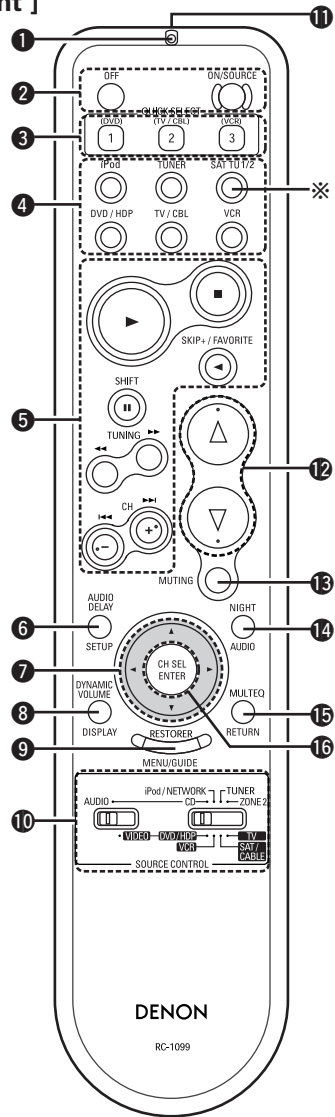

- 1 Indicator ..... (65)
- 2 Power buttons ..... (54)
- 3 QUICK SELECT buttons ..... (64)
- 4 Source select buttons ..... (54)  
※ : To select "SIRIUS", "XM" as the input source, use the **SAT TU1/2** button.
- 5 System buttons ..... (60)
- 6 AUDIO DELAY button ..... (51)
- 7 Cursor buttons (Δ▽◀▶) ..... (57)
- 8 DYNAMIC VOLUME button ..... (50)
- 9 RESTORER button ..... (51)
- 10 SOURCE CONTROL switches ..... (22, 65)
- 11 Remote control signal transmitter ..... (3)
- 12 Master volume control buttons ..... (54)
- 13 MUTING button ..... (54)
- 14 NIGHT button ..... (51)
- 15 MULTEQ button ..... (49)
- 16 Channel select (CH SEL) / ENTER button ..... (59, 63)

[ Rear ]

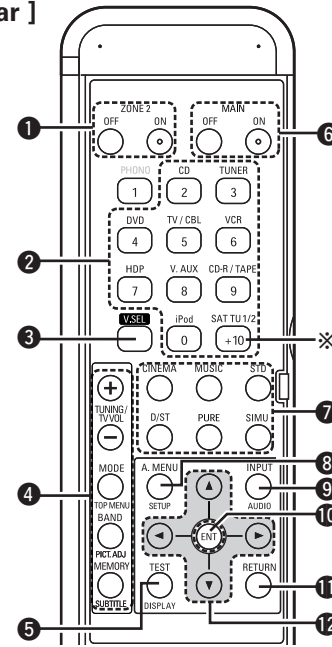

- 1 ZONE2 power buttons ..... (72)
- 2 Source select buttons ..... (54)  
※ : To select "SIRIUS", "XM" as the input source, use the **SAT TU1/2** button.
- 3 Video select button (V.SEL) ..... (39)
- 4 Tuner system buttons ..... (55)
- 5 Test tone button (TEST) ..... (31)
- 6 MAIN ZONE power buttons (MAIN) ..... (72)
- 7 Surround mode buttons ..... (45, 46)
- 8 Amp menu button (A. MENU) ..... (22)
- 9 Input mode button (INPUT) ..... (17, 41)
- 10 Enter button (ENT) ..... (22)
- 11 RETURN button ..... (22)
- 12 Cursor buttons (Δ▽◀▶) ..... (22)

## □ Sub remote control unit for ZONE2 (RC-1107)

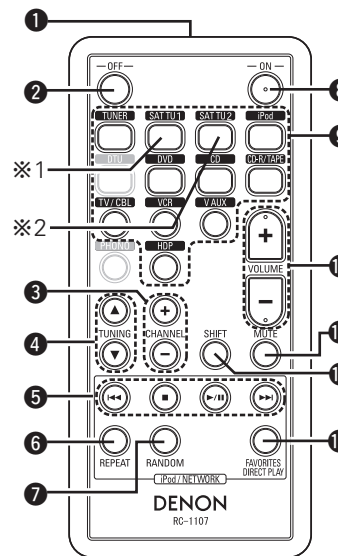

- 1 Remote control signal transmitter ..... (3)
- 2 Zone power off button (OFF) ..... (68)
- 3 CHANNEL buttons ..... (68)
- 4 TUNING buttons ..... (68)
- 5 System buttons ..... (68)
- 6 REPEAT button ..... (68)
- 7 RANDOM button ..... (68)
- 8 Zone power on button (ON) ..... (68)
- 9 Source select buttons ..... (68)  
※1 : To select "SIRIUS" as the input source, use the **SAT TU1** button.  
※2 : To select "XM" as the input source, use the **SAT TU2** button.
- 10 Volume control buttons (VOLUME) ..... (68)
- 11 Muting button (MUTE) ..... (68)
- 12 SHIFT button ..... (68)
- 13 FAVORITES DIRECT PLAY button ..... (68)

**NOTE**

The **DTU** and **PHONO** buttons cannot be used.



The **FAVORITES DIRECT PLAY** button can function when the control dock for iPod ASD-3N/3W is used.

**NOTE**

If buttons on the front or rear are pressed strongly, the button on the opposite side will be activated too.

# Connections

Connections for all compatible audio and video signal formats are described in this owner's manual. Please select the types of connections suited for the equipment you are connecting. With some types of connections, certain settings must be made on the AVR-1909. For details, refer to the instructions for the respective connection items below.



























































































**NOTE**

- Do not plug in the power cord until all connections have been completed.
- When making connections, also refer to the operating instructions of the other components.
- Be sure to connect the left and right channels properly (left with left, right with right).
- Do not bundle power cords together with connection cables. Doing so can result in humming or noise.

## Preparations

### Cables Used for Connections

Select the cables according to the equipment being connected.

Audio cables	Video cables								
<p><b>Coaxial digital connections</b></p> <p>(Orange)   </p> <p>Coaxial digital (75 Ω/ohms pin-plug) cable</p> <p><b>Optical digital connections</b></p> <p>  </p> <p>Optical cable</p> <p><b>Analog connections (stereo)</b></p> <p>(White)   </p> <p>(Red)   </p> <p>Stereo pin-plug cable</p> <p><b>Analog connections (monaural, for subwoofer)</b></p> <p>(Black)   </p> <p>Pin-plug cable</p> <p><b>Speaker connections</b></p> <p>  </p> <p>Speaker cables</p>	<p><b>Component video connections</b></p> <p>(Green)    (Y)</p> <p>(Blue)    (PB/CB)</p> <p>(Red)    (PR/CR)</p> <p>Component video cable</p> <p><b>S-Video connections</b></p> <p>  </p> <p>S-Video cable</p> <p><b>Video connections</b></p> <p>(Yellow)   </p> <p>75 Ω/ohms pin-plug video cable</p> <tr> <th colspan="2" style="background-color: #cccccc;">Audio and video cables</th> </tr> <tr> <td colspan="2"> <p><b>HDMI connections</b></p> <p>  </p> <p>19-pin HDMI cable</p> <tr> <th colspan="2" style="background-color: #cccccc;">Signal direction</th> </tr> <tr> <td colspan="2"> <p>Audio signal:</p> <p>Output  Input </p> <p>Input  Output </p> <p>Video signal:</p> <p>Output  Input </p> <p>Input  Output </p> </td> </tr> </td></tr>	Audio and video cables		<p><b>HDMI connections</b></p> <p>  </p> <p>19-pin HDMI cable</p> <tr> <th colspan="2" style="background-color: #cccccc;">Signal direction</th> </tr> <tr> <td colspan="2"> <p>Audio signal:</p> <p>Output  Input </p> <p>Input  Output </p> <p>Video signal:</p> <p>Output  Input </p> <p>Input  Output </p> </td> </tr>		Signal direction		<p>Audio signal:</p> <p>Output  Input </p> <p>Input  Output </p> <p>Video signal:</p> <p>Output  Input </p> <p>Input  Output </p>	
Audio and video cables									
<p><b>HDMI connections</b></p> <p>  </p> <p>19-pin HDMI cable</p> <tr> <th colspan="2" style="background-color: #cccccc;">Signal direction</th> </tr> <tr> <td colspan="2"> <p>Audio signal:</p> <p>Output  Input </p> <p>Input  Output </p> <p>Video signal:</p> <p>Output  Input </p> <p>Input  Output </p> </td> </tr>		Signal direction		<p>Audio signal:</p> <p>Output  Input </p> <p>Input  Output </p> <p>Video signal:</p> <p>Output  Input </p> <p>Input  Output </p>					
Signal direction									
<p>Audio signal:</p> <p>Output  Input </p> <p>Input  Output </p> <p>Video signal:</p> <p>Output  Input </p> <p>Input  Output </p>									

## Video Conversion Function

- This function automatically converts various formats of video signals input to the AVR-1909 into the format used to output the video signals from the AVR-1909 to a monitor.
- The AVR-1909's video input/output circuitry is compatible with the following four types of video signals:  
 Digital video signals: HDMI  
 Analog video signals: Component video, S-Video and Video

[Flow of video signals inside the AVR-1909]

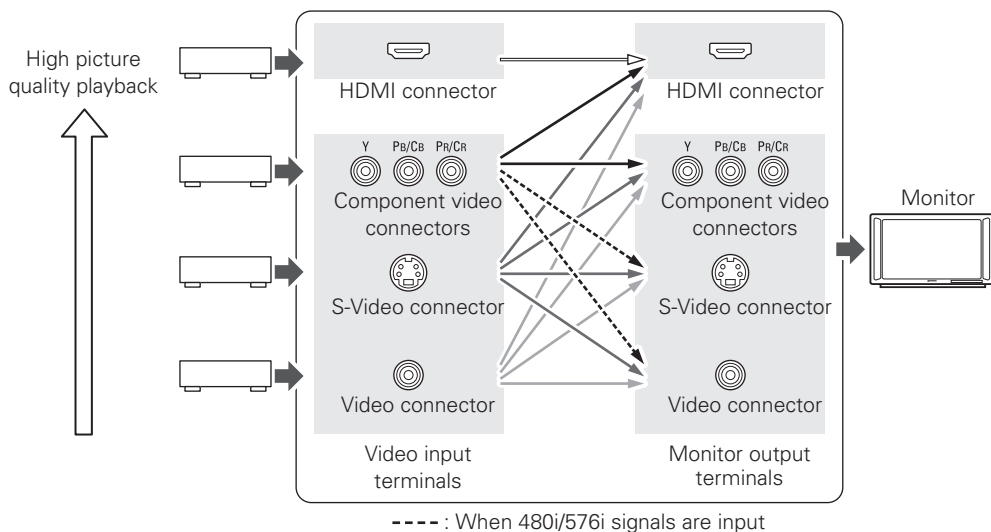

- When not using this function, connect a monitor output with the same type of connector as the video input connector.
- The resolution of the HDMI input-compatible monitor connected to the AVR-1909 can be checked at menu "Information" – "HDMI Information" (page 53).

### NOTE

- HDMI signals cannot be converted into analog signals.
- 1080p component input video signals cannot be output to anything other than component video connectors.
- 480p/576p, 1080i and 720p component video input signals cannot be converted into S-Video or Video format.
- When a non-standard video signal from a game machine or some other source is input, the video conversion function might not operate.

## On-Screen Display for Component Video Outputs and HDMI Output

- When viewing HDMI or component video signals via the AVR-1909, the on-screen display appears when the **MENU** button on the main unit or the **A.MENU** button on the main remote control unit is operated.
- When only HDMI or component video signals are input to the AVR-1909, the characters of the on-screen display are not displayed over the picture.

# Speaker Connections

## Speaker Installation

The illustration below shows a basic example of installation of the amplifier combined with 8 speakers and a monitor.

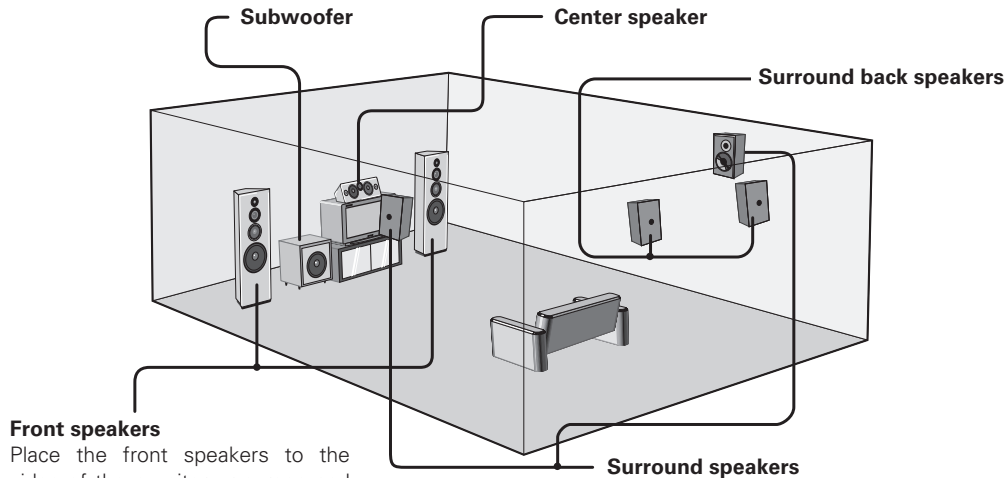

### Front speakers

Place the front speakers to the sides of the monitor or screen and as flush with the screen surface as possible.



The table below shows a typical speaker configuration for the AVR-1909.

	FRONT		CENTER	SURROUND		SURROUND BACK			SUBWOOFER
	L	R		L	R	L	R	1 speaker	
7.1-channels (FRONT A+B)	○	○	○	○	○	○	○	-	○
7.1-channels	○	○	○	○	○	○	○	-	○
6.1-channels	○	○	○	○	○	-	-	○	○
5.1-channels	○	○	○	○	○	-	-	-	○
3.1-channels	○	○	○	-	-	-	-	-	○
2.1-channels	○	○	-	-	-	-	-	-	○
2-channels	○	○	-	-	-	-	-	-	-

# Speaker Connections

Example: 5.1/7.1-channels

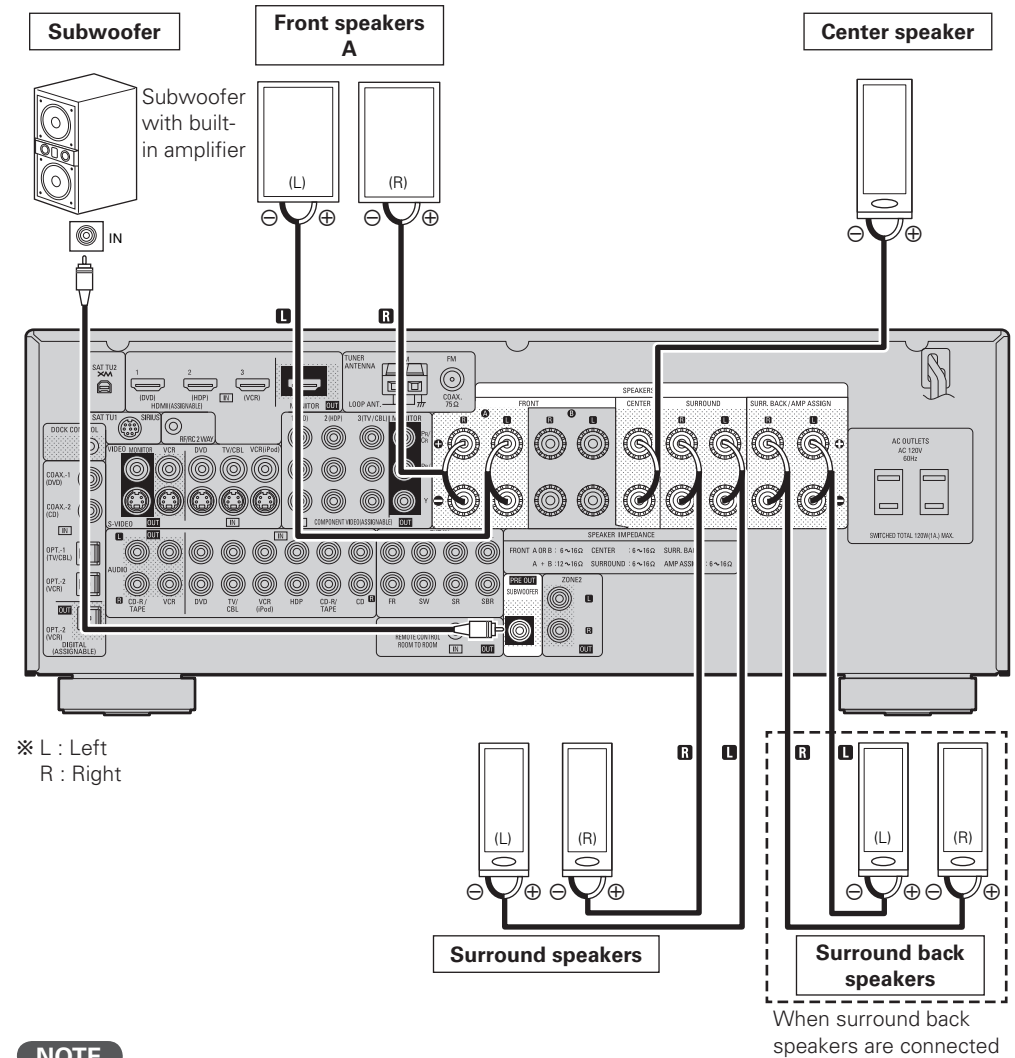

※ L : Left  
R : Right

### NOTE

#### For surround back speakers :

- Since "Amp Assign" of AVR-1909 is set to "ZONE2" by default, audio is not output from the surround back speakers. When using the surround back speakers with MAIN ZONE, change the "Amp Assign" setting to "7.1ch" (page 35).
- When using just one surround back speaker, connect it to the left channel (SBL).

#### For ZONE2 speakers :

- For multi-zone connection and operation, see "Amp Assign / Multi-zone Connections and Operations" (page 69 ~ 72).

## Connecting the Speaker Cables

Carefully check the left (L) and right (R) channels and + (red) and – (black) polarities on the speakers being connected to the AVR-1909, and be sure to interconnect the channels and polarities correctly.

**1** Peel off about 0.03 ft/10 mm of sheathing from the tip of the speaker cable, then either twist the core wire tightly or terminate it.



**2** Turn the speaker terminal counterclockwise to loosen it.



**3** Insert the speaker cable's core wire to the hilt into the speaker terminal.



**4** Turn the speaker terminal clockwise to tighten it.



### When using a banana plug

Tighten the speaker terminal firmly before inserting the banana plug.



### NOTE

- Use speakers with an impedance of 6 to 16  $\Omega$ /ohms. When using front A and B speakers simultaneously, use speakers with an impedance of 12 to 16  $\Omega$ /ohms.
- Connect the speaker cables in such a way that they do not stick out of the speaker terminals. The protection circuit may be activated if the core wires touch the rear panel or if the + and – sides touch each other (☞ "Protection circuit").
- Never touch the speaker terminals while the power supply is connected. Doing so could result in electric shock.

### Protection circuit

If the core wires touch the rear panel and the screws etc., or the  $\pm$  sides touch each other, the protection circuit will be activated and the power indicator will flash red at intervals of 0.5 secs.

If the protection circuit is activated, the speaker output is isolated, and the power supply goes to the standby state. If the power supply is turned off, after the power supply cord is withdrawn, please confirm that speaker cable and input cable are connected.

Also, if replaying large sound levels by using a speaker having an impedance less than that specified (eg, 4  $\Omega$ /ohms), the temperature will rise, and the protection circuit might be activated. The power supply will go into the standby state, and the power indicator will flash red at 2 second intervals.

In this case, please switch off the power supply, and wait until the AVR-1909 has cooled down, and the surrounding ventilation is good.

Even if there are no problems with the surrounding ventilation and connections, in the event of the protection circuit becoming activated, due to thinking that the AVR-1909 has failed, please contact DENON Service center after switching off.



# Connecting Equipment with HDMI connectors

With HDMI connections, the video and audio signals can be transferred with a single cable.

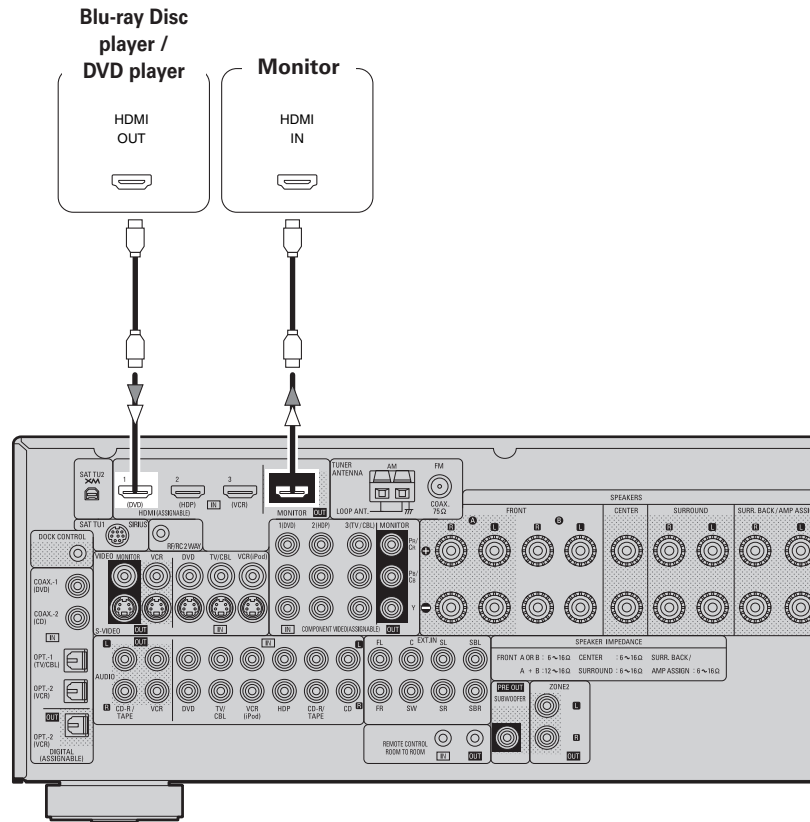

- ※ The AVR-1909 is equipped for HDMI version 1.3a. This version is compatible with other versions, allowing connection to all components equipped with an HDMI connector.
- ※ The AVR-1909 is compatible with 30- and 36-bit Deep Color.

Compatible audio format	Details	Discs (examples)
2-channel linear PCM	2ch 32-192 kHz 16/20/24 bits	CD, DVD-Video, DVD-Audio
Multi-channel linear PCM	8ch 32-192 kHz 16/20/24 bits	DVD-Audio, Blu-ray
Dolby Digital, DTS	Bitstream	DVD-Video
Dolby Digital Plus, Dolby TrueHD, DTS-HD	Bitstream	Blu-ray

- By default, the HDMI audio signals are output from the speakers connected to the AVR-1909.
- To output the sound from the TV, make the settings at menu "Manual Setup" – "HDMI Setup" – "HDMI Audio Out" – "TV" (page 32).

## NOTE

- The AVR-1909 cannot be controlled from another device via the HDMI cable.
- The audio signals output from the HDMI connector (sampling frequency, bit rate, etc.) may be restricted by the connected device.
- Video signals are not output properly when using devices that are not HDCP-compatible.
- Video signals are not output if the input video signals do not match the monitor's resolution. In this case, switch the Blu-ray Disc player / DVD player's resolution to a resolution with which the monitor is compatible.
- If the menu "Manual Setup" – "HDMI Setup" – "HDMI Audio Out" setting (page 32) is set to "AMP", the sound may be interrupted when the monitor's power is turned off.
- Use a cable on which the HDMI logo is indicated (a certified HDMI product) for connection to the HDMI connector. Normal playback may not be possible when using a cable other than one on which the HDMI logo is indicated (a non-HDMI-certified product).
- If the monitor or Blu-ray Disc player / DVD player does not support Deep Color, deep color signal transfer is not possible.
- If the monitor or Blu-ray Disc player / DVD player does not support xvYCC, xvYCC signal transfer is not possible.
- If the monitor does not support "Auto Lipsync Correction" function, this function will not work.
- The AVR-1909 is compatible with the HDMI's CEC (Consumer Electronics Control) function. Please note the following.
  - It may not work depending on the device it is connected to and its setup.
  - It does not operate with televisions or players that are not compatible with HDMI's CEC.



- When the AVR-1909 and Blu-ray Disc player / DVD player are connected using an HDMI cable, also connect the AVR-1909 and monitor using an HDMI cable.
- If the connected monitor or Blu-ray Disc player / DVD player only has a DVI-D connector, use an HDMI/DVI converter cable. **When using a DVI cable, no audio signals are transmitted.**
- Use a Deep Color compatible cable for connection to Deep Color compatible devices.

### When connecting with an HDMI/DVI converter cable (adapter)

- HDMI video signals are theoretically compatible with the DVI format. When connecting to a monitor, etc., equipped with a DVI-D connector, connection is possible using an HDMI/DVI converter cable, but depending on the combination of components in some cases the video signals will not be output.
- When connecting using an HDMI/DVI converter adapter, the video signals may not be output properly due to poor connections with the connected cable, etc.

### Copyright protection system (HDCP)

In order to play the digital video and audio signals of a Blu-ray, DVD-Video or DVD-Audio disc using HDMI/DVI connections, both the connected Blu-ray Disc player / DVD player and monitor must be equipped for a copyright protection system called "HDCP" (High-bandwidth Digital Content Protection). HDCP is a copy protection technology consisting of data encoding and mutual identification of the devices. The AVR-1909 is HDCP-compatible. For details on the Blu-ray Disc player / DVD player or monitor you are using, refer to its operating instructions.



## Connecting the Monitor

- Select the terminal to use and connect the device (☞ page 9 “Video Conversion Function”).
- With HDMI connections, the video and audio signals can be transferred with a single cable.
- To output the audio signals to the monitor with HDMI connections, set menu “Manual Setup” – “HDMI Setup” – “HDMI Audio Out” to “TV” (☞ page 32).

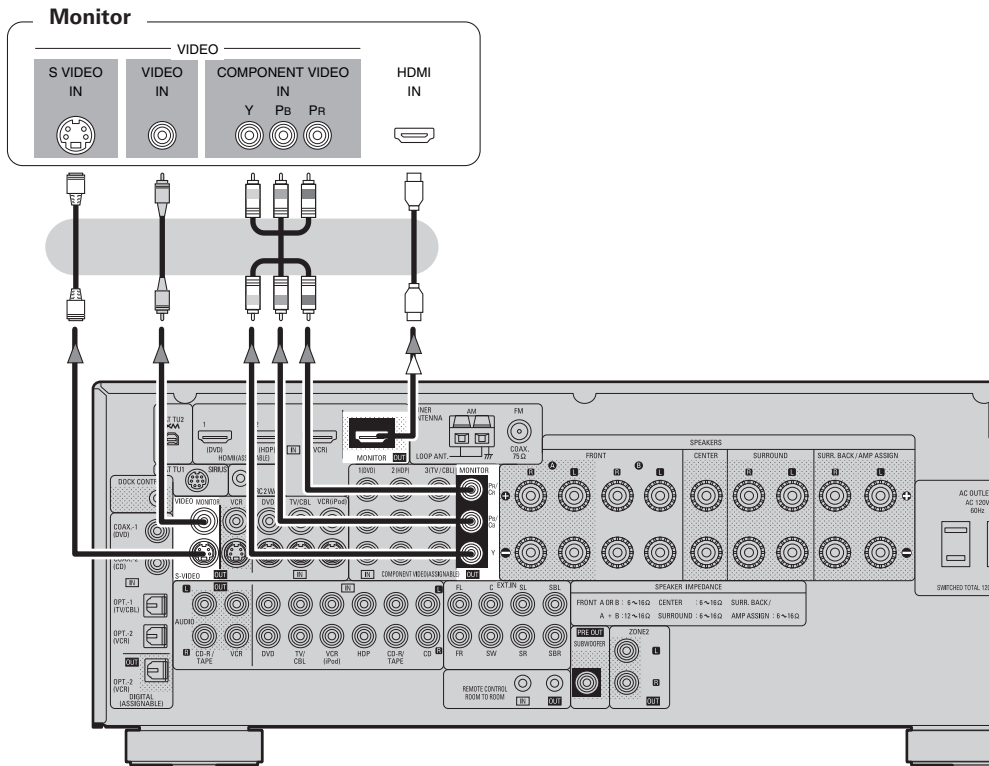

### NOTE

- The component video connectors may be indicated differently on your monitor. For details, see the monitor’s operating instructions.
- The audio signals output from the HDMI connectors are only the HDMI input signals.

## Connecting the Playback Components

Carefully check the left (L) and right (R) channels and the inputs and outputs, and be sure to interconnect correctly.

### Blu-ray Disc player / DVD player

Select the terminal to use and connect the device.

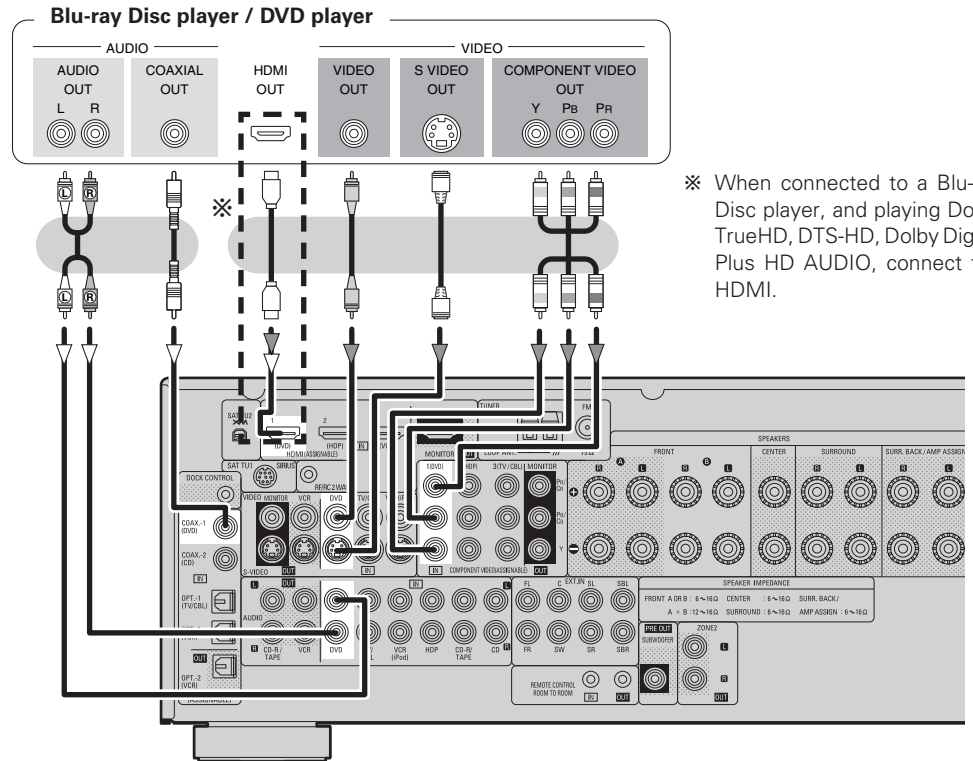

※ When connected to a Blu-ray Disc player, and playing Dolby TrueHD, DTS-HD, Dolby Digital Plus HD AUDIO, connect the HDMI.



When using an optical cable for the digital audio connection, make the settings at menu “Input Setup” – “Assign” – “Digital In” (☞ page 42).

CD Player

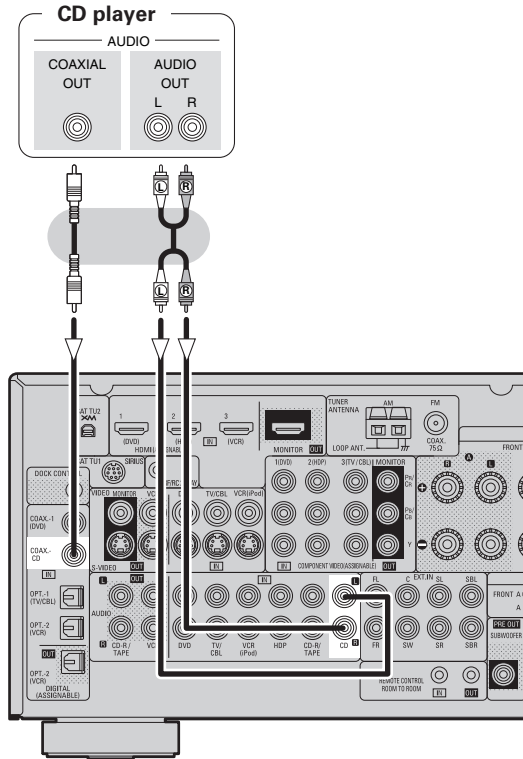

When using an optical cable for the digital audio connection, make the settings at menu "Input Setup" – "Assign" – "Digital In" (page 42).

iPod®

Use a DENON control dock for iPod (ASD-1R, ASD-3N or ASD-3W sold separately) to connect the iPod to the AVR-1909. For instructions on the control dock for iPod settings, refer to the control dock for iPod's operating instructions.

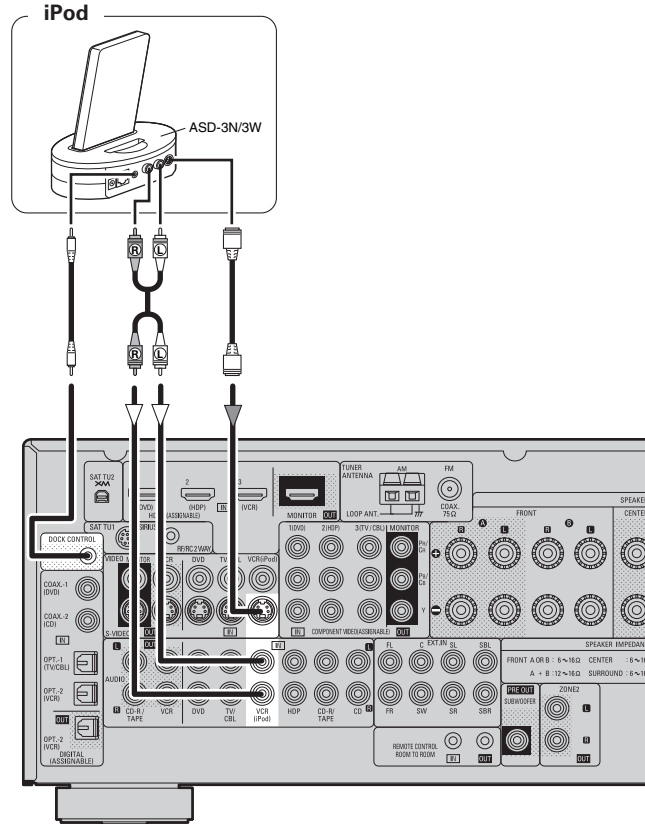

- With the default settings, the iPod can be used connected to the VCR (iPod) connector.
- To assign the iPod to a connector other than VCR (iPod), make the settings at menu "Input Setup" – "(input source to which iPod dock assigned)" – "Assign" – "iPod dock" (page 42).

## TV/CABLE Tuner

Select the terminal to use and connect the device.

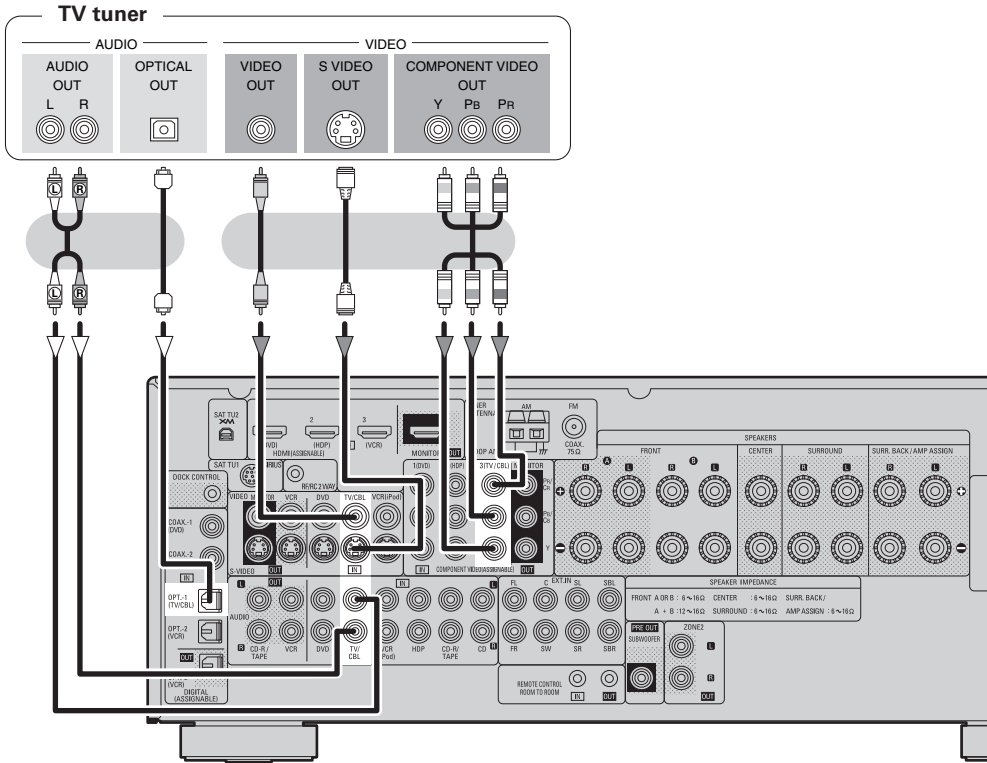

When using a coaxial cable for the digital audio connection, make the settings at menu "Input Setup" - "Assign" - "Digital In" (page 42).

## Connecting the Recording Components

Carefully check the left (L) and right (R) channels and the inputs and outputs, and be sure to interconnect correctly.

### Video Cassette Recorder

Select the terminal to use and connect the device.

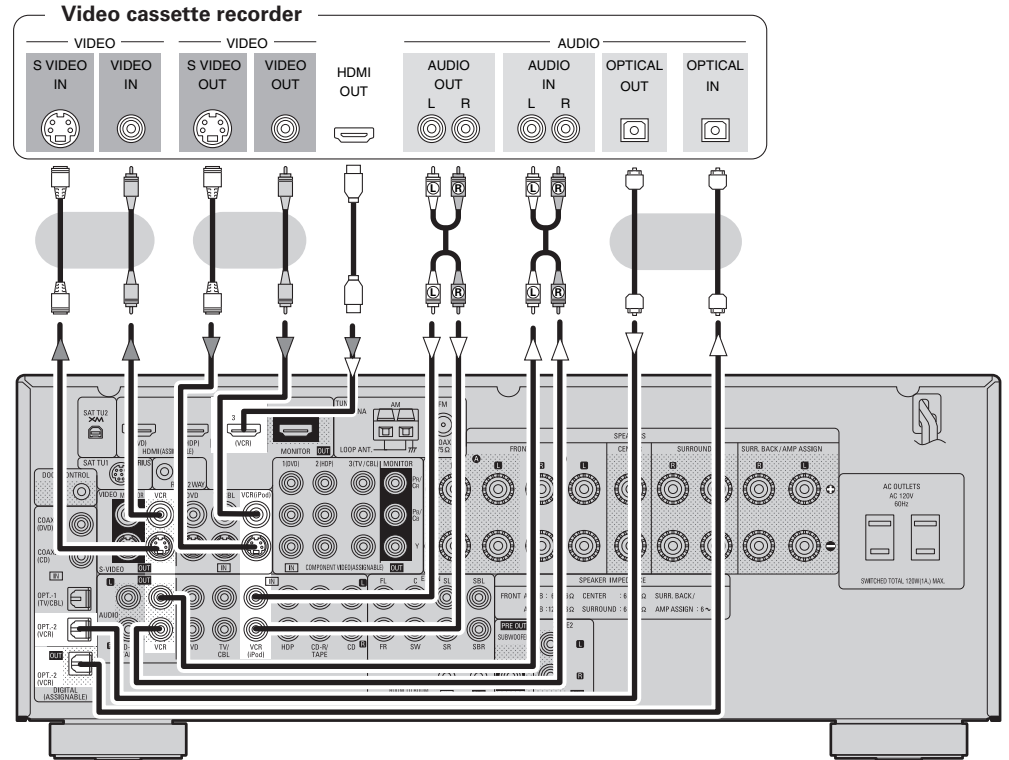

When recording via the AVR-1909, the playback device's cable must be of the same type as the cable used to connect the AVR-1909's VCR OUT connector.

**Example:** TV IN → S-Video cable : VCR OUT → S-Video cable

TV IN → Video cable : VCR OUT → Video cable

When using a component video cable for the video connection, make the settings at menu "Input Setup" - "Assign" - "Component In" (page 42).

#### NOTE

Do not connect the output of the component connected to the AVR-1909's OPTICAL2 output connector to any input connector other than OPTICAL2.

### CD Recorder / MD Recorder / Tape Deck

Make analog connections if you wish to record analog audio signals, or digital connections if you wish to record digital audio signals, depending on the types of connectors on the components being used.

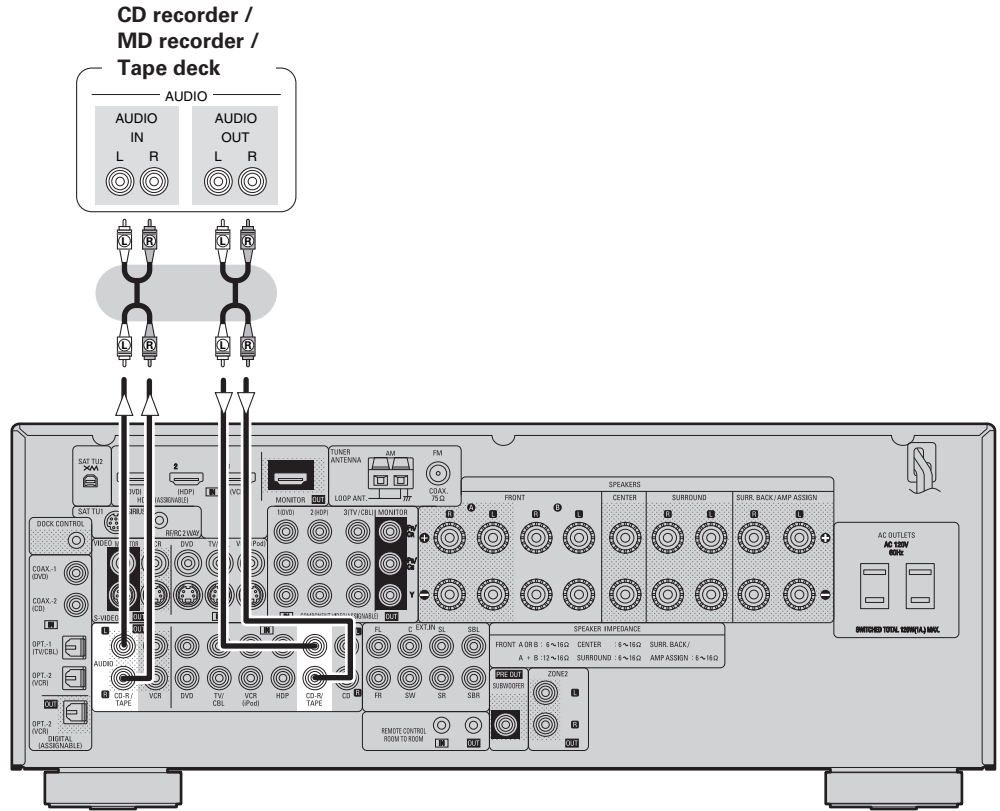

### Connections to Other Devices

Carefully check the left (L) and right (R) channels and the inputs and outputs, and be sure to interconnect correctly.

### Video Camera / Game Console

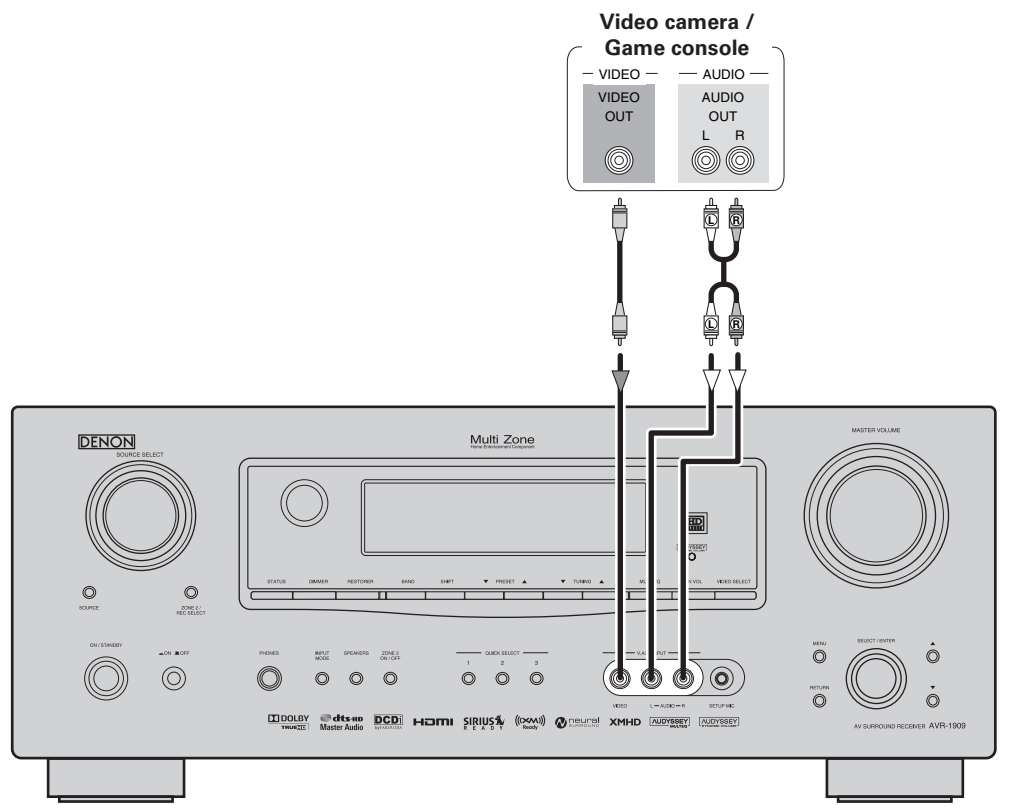

### Component with Multi-channel Output connectors

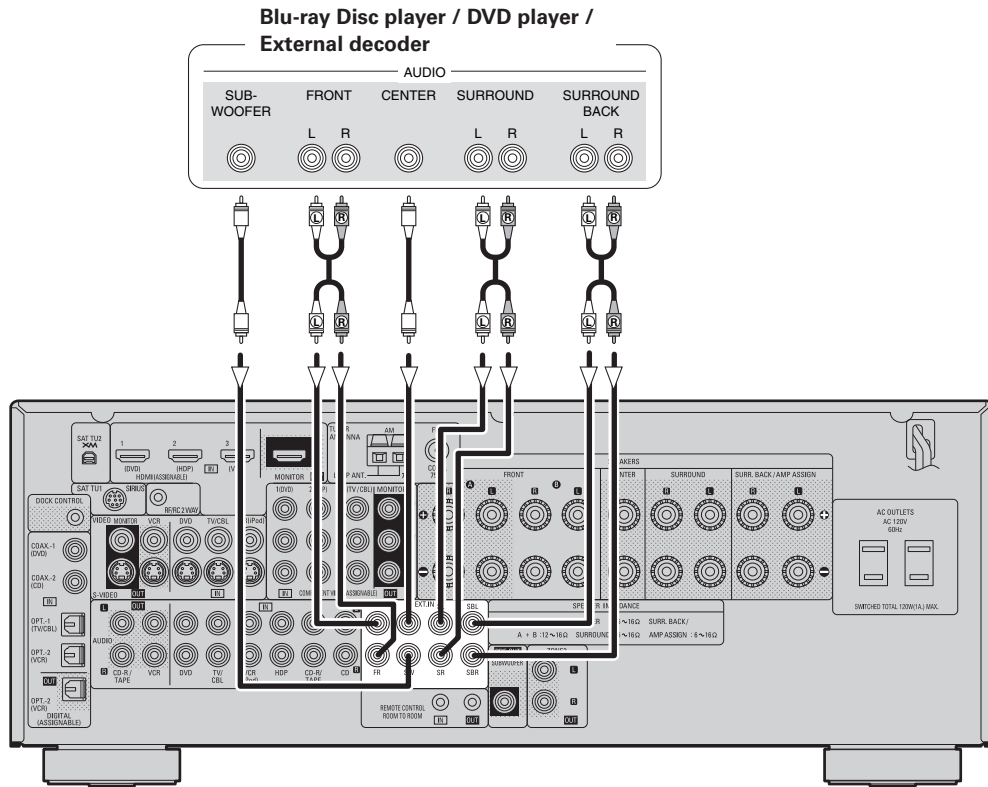

- To play the analog input signals input to the EXT. IN connectors, press the **INPUT MODE** button on the main unit or **INPUT** button on the main remote control unit and select "EXT. IN" or make the settings at menu "Input Setup" – "Input Mode" – "Input Mode" – "EXT. IN" (page 41).
- The video signal can be connected in the same way as a Blu-ray Disc player / DVD player (page 13).

### XM connector

- The AVR-1909 is an XM Ready® receiver. You can receive XM® Satellite Radio by connecting to the XM Mini-Tuner and Home Dock (includes home antenna, sold separately) and subscribing to the XM service.
- Plug the XM Mini-Tuner and Home Dock into the XM connector on the rear panel.
- Position the Home Dock antenna near a south-facing window to receive the best signal. For details, see "Listening to XM Satellite Radio Programs" (page 56, 57). When making connections, also refer to the operating instructions of the XM Mini-Tuner and Home Dock.

#### XM Mini-Tuner and Home Dock

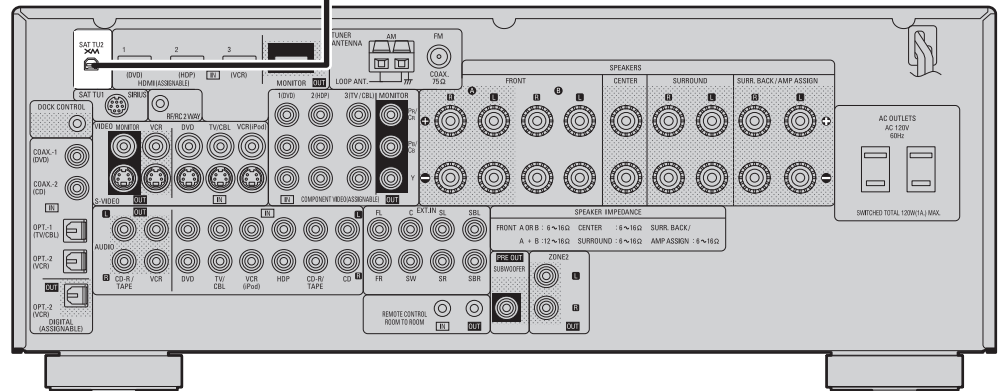
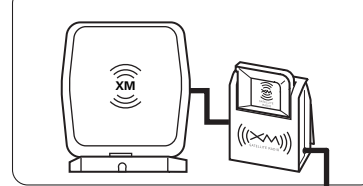

#### NOTE

Keep the power cord unplugged until the XM Mini-Tuner and Home Dock connection have been completed.

- The XM name and related logo are registered trademarks of XM Satellite Radio Inc. All rights reserved.
- XM Ready® is a registered trademark of XM Satellite Radio Inc. All rights reserved.

## SIRIUS connector

- The AVR-1909 is a SIRIUS Satellite Radio Ready® receiver. You can receive SIRIUS® Satellite Radio by connecting to the SiriusConnect Home Tuner and subscribing to the SIRIUS service.
- Plug the SIRIUS connector on the rear panel.
- Position the Home Tuner antenna near a south-facing window to receive the best signal. For details, see “Listening to SIRIUS Satellite Radio Programs” (page 57 ~ 59). When making connections, also refer to the operating instructions of the SiriusConnect Home Tuner.

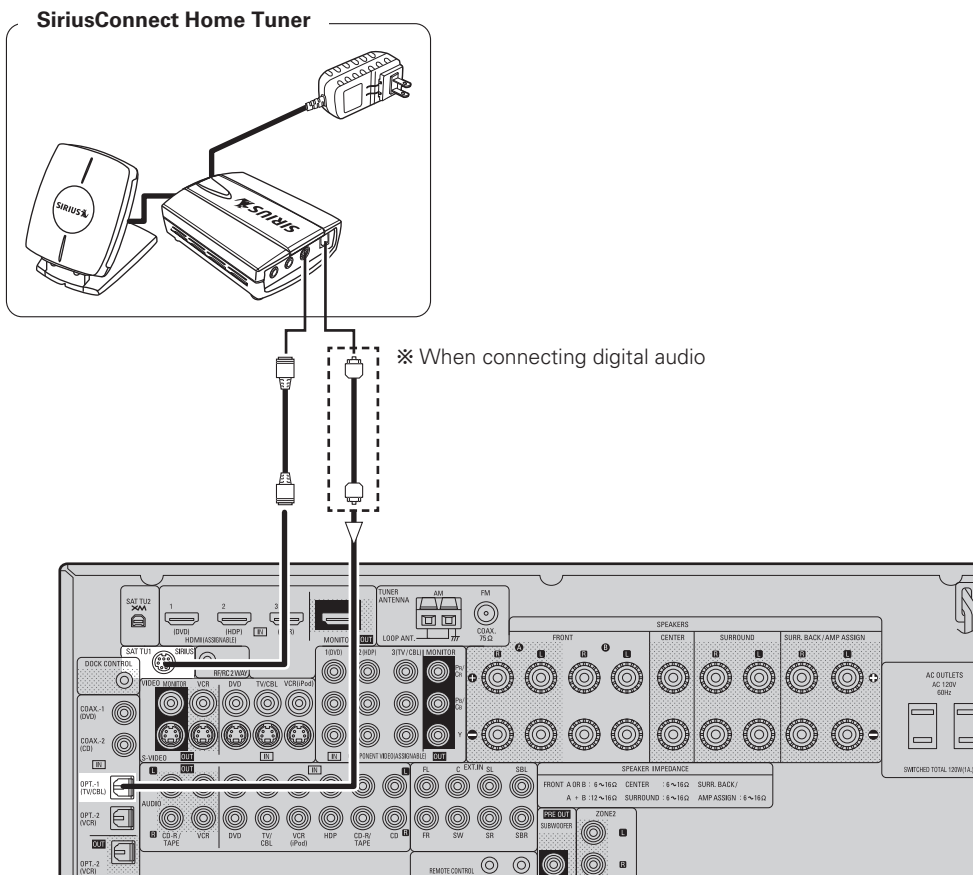

When connecting digital of the SiriusConnect Home Tuner, perform the setting “Input Setup” – “Assign” – “Digital In” from the menu. (page 42).

### NOTE

Keep the power cord unplugged until the SiriusConnect Home Tuner connection have been completed.

© 2006 SIRIUS Satellite Radio Inc. “SIRIUS”, the SIRIUS dog logo, and channel names and logos are trademarks of SIRIUS Satellite Radio Inc.

### Positioning the Antenna

For a consistent satellite signal, the antenna must be positioned correctly. Use the following map to determine which area you are in and position the antenna accordingly.

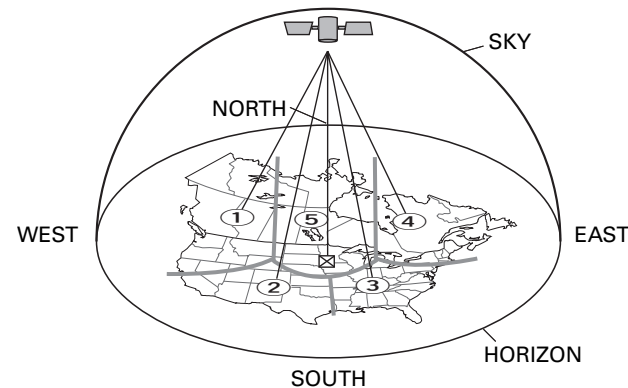

**Area 1 :** Point the antenna toward the sky in the **east, northeast, or southeast**, either through a window or outside.

**Area 2 :** Point the antenna toward the sky in the **north or northeast**, either through a window or outside.

**Area 3 :** Point the antenna toward the sky in the **north or northwest**, either through a window or outside.

**Area 4 :** Point the antenna toward the sky in the **west, northwest, or southwest**, either through a window or outside.

**Area 5 :** Put the antenna outside and point it **straight up**. The antenna cannot be used indoors.



## Antenna terminals

An F-type FM antenna cable plug can be connected directly.

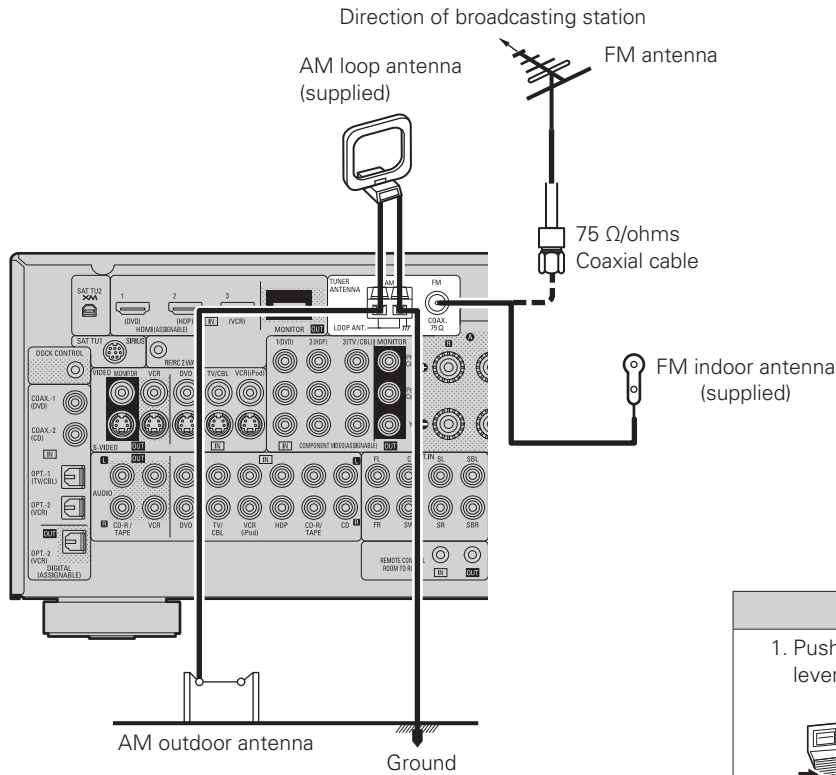

### Connection of AM antennas

1. Push the lever.
2. Insert the conductor.
3. Return the lever.



### NOTE

- Do not connect two FM antennas simultaneously.
- Even if an external AM antenna is used, do not disconnect the AM loop antenna.
- Make sure the AM loop antenna lead terminals do not touch metal parts of the panel.

### Note to CATV system installer:

This reminder is provided to call the CATV system installer's attention to Article 820-40 of the NEC which provides guidelines for proper grounding and, in particular, specifies that the cable ground shall be connected to the grounding system of the building, as close to the point of cable entry as practical.

### AM loop antenna assembly

1. Remove the vinyl tie and take out the connection line.
2. Connect to the AM antenna terminals.
3. Bend in the reverse direction.

4.
    - a. With the antenna on top of any stable surface.
    - b. With the antenna attached to a wall.
- Mount
- Installation hole Mount on wall, etc.



## Multi-zone

### ZONE2 out Connections

If another pre-main (integrated) amplifier is connected, the ZONE2 out connectors can be used to play a different program source in ZONE2 at the same time (page 69 ~ 72).

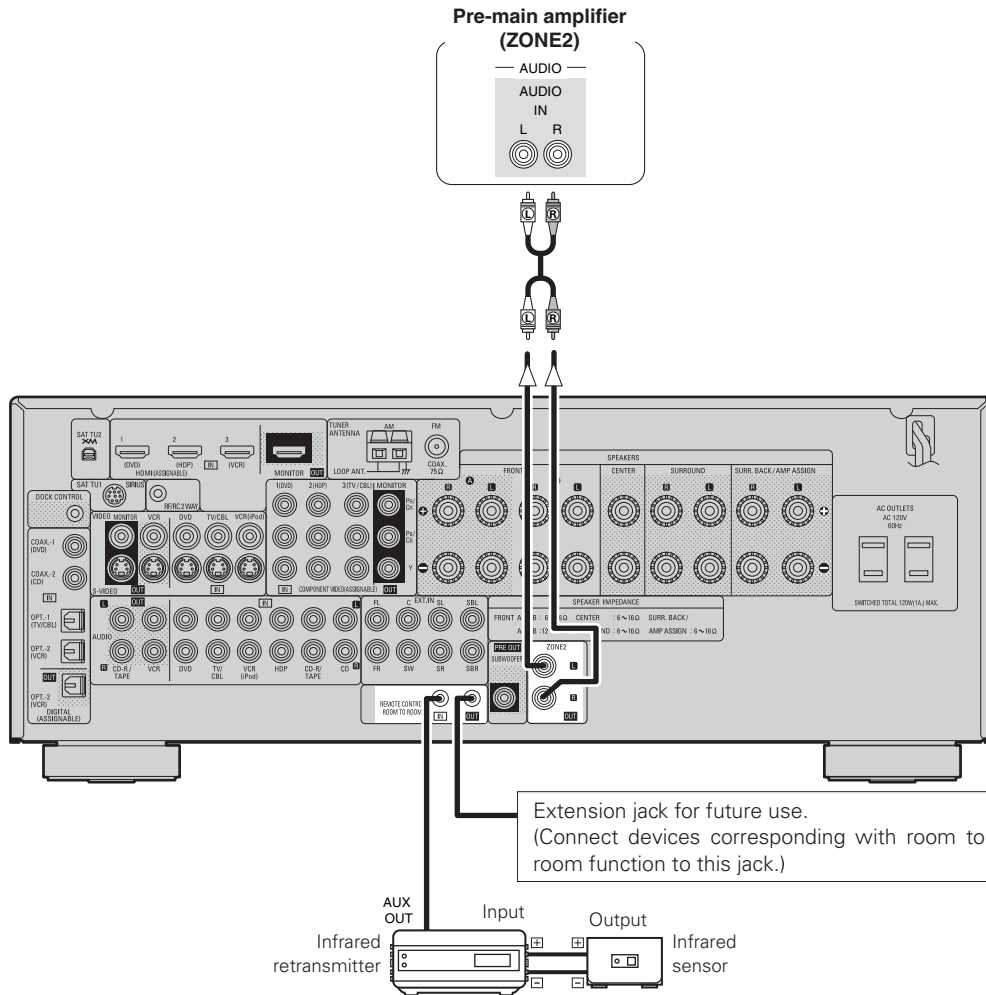

#### NOTE

- For the audio output, use high quality pin-plug cords so that no induction humming or noise is produced.
- For instructions on installing and operating separately sold devices, refer to the respective devices' operating instructions.
- To conduct multi-zone playback, see "Amp Assign / Multi-zone Connections and Operations" (page 69 ~ 72).

## External Controller

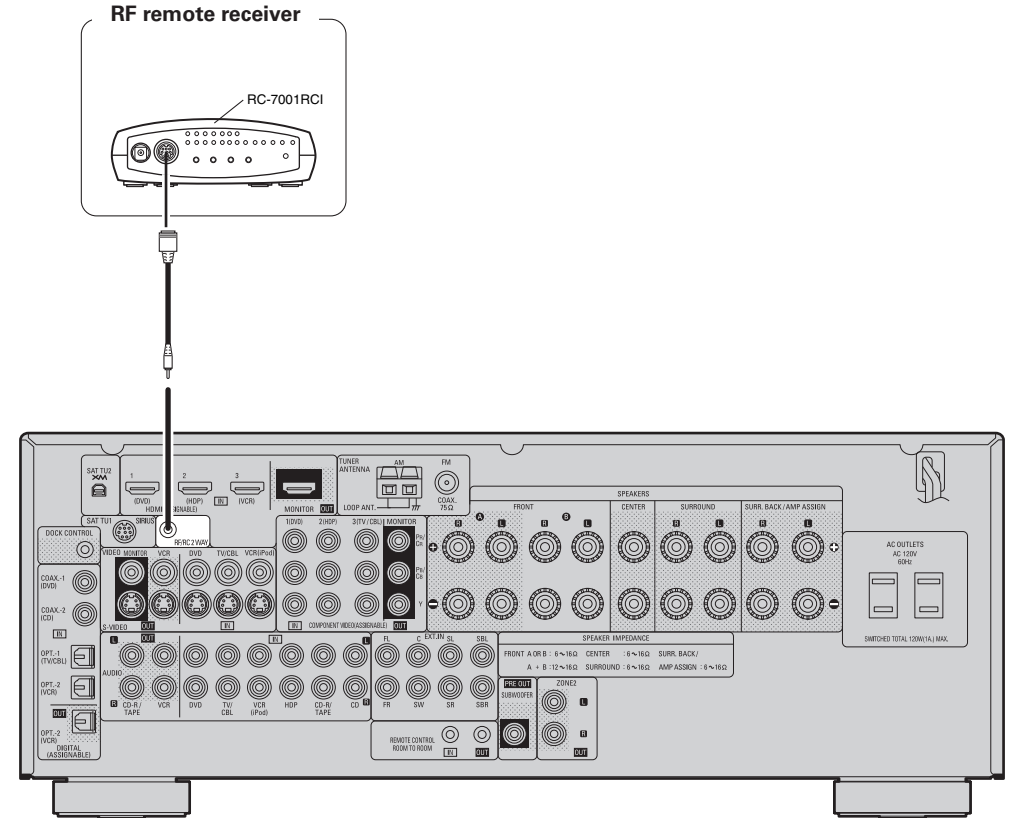

- When using in combination with an RF Remote Controller (RC-7000CI, sold separately) or RF Remote Receiver (RC-7001RCI, sold separately) two-way communication with an RF Remote Controller is possible. The AVR-1909's status information as well as iPod can be browsed watching the RF Remote Controller's display. For details, refer to the operating instructions of the respective devices.
- When used in combination with an RF Remote Controller or RF Remote Receiver, make the settings at menu "Manual Setup" – "Option Setup" – "2Way Remote" – "Used" (page 36).

## Connecting the Power Cord

Wait until all connections have been completed before connecting the power cord.

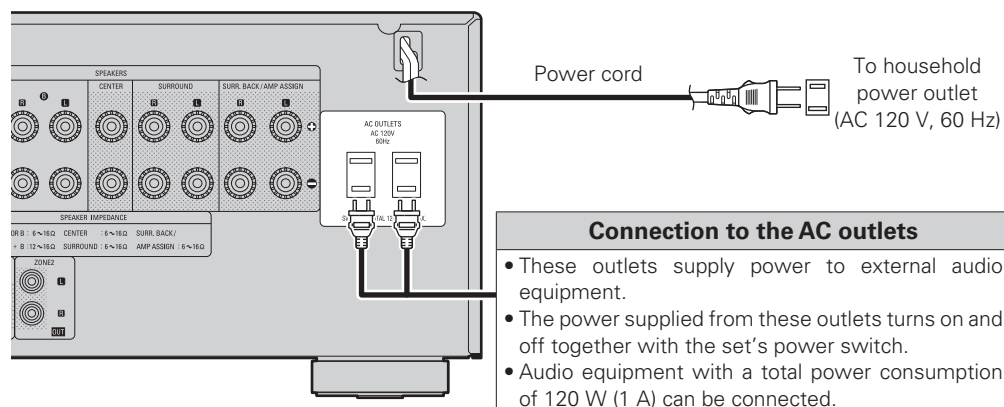

### NOTE

- Insert the AC plugs securely. Incomplete connections could cause noise.
- Only use the AC outlets to plug in audio equipment. Do not use them as power supplies for hairdryers or anything other than audio equipment.

## Once Connections are Completed

**Turning the Power On** (🔍 page 54)

# Menu Operations

**Symbols used to indicate buttons in this manual**

- Button located on both the main unit and the remote control unit → **BUTTON**
- Button only on the main unit → **<BUTTON>**
- Button only on the remote control unit → **[BUTTON]**

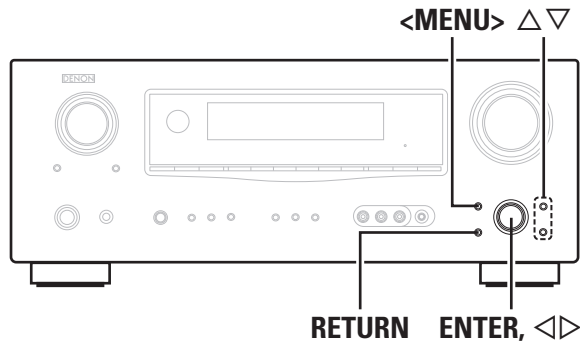

[Front]

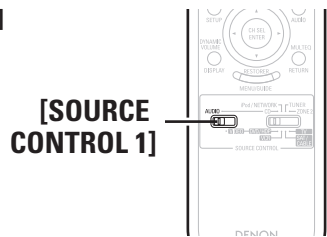

[Rear]

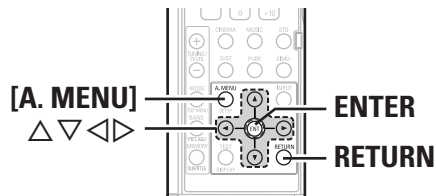

With the AVR-1909, settings and operations for most functions can be performed by operating while looking at the menus displayed on the monitor screen.

## Operations

The same operation is possible on the main unit or main remote control unit.

- 1 Press <MENU> or [A.MENU].**  
The menu is displayed.  
※ To operate from the main remote control unit, be sure to set the **[SOURCE CONTROL 1]** to "AUDIO".
- 2 Press  $\Delta$ / $\nabla$  to select the item you want to set, then press ENTER.**
- 3 Press  $\Delta$ / $\nabla$  again to select the item you want to set, then press ENTER.**
- 4 To change the setting:**  
**4 Press  $\Delta$ / $\nabla$  to select the item you want to change, then press  $\triangleleft$ / $\triangleright$  to change the setting.**  
※ To return to the previous item, press **RETURN**.  
※ Select "Default Yes", then press  $\triangleleft$  to reset to the default setting.
- 5 Press ENTER to enter the setting.**
- 6 Press <MENU> or [A.MENU] to finish.**



When **<MENU>** or **[A.MENU]** is pressed, the settings made up to that point are entered and the settings menu screen turns off.

## Example of Display of Default Values

In lists of selectable items or adjustable ranges, the item surrounded by a border is the default value.

[Selectable items] **A** B A + B

# Examples of On-screen Display and Front Display

Some typical examples are described below.

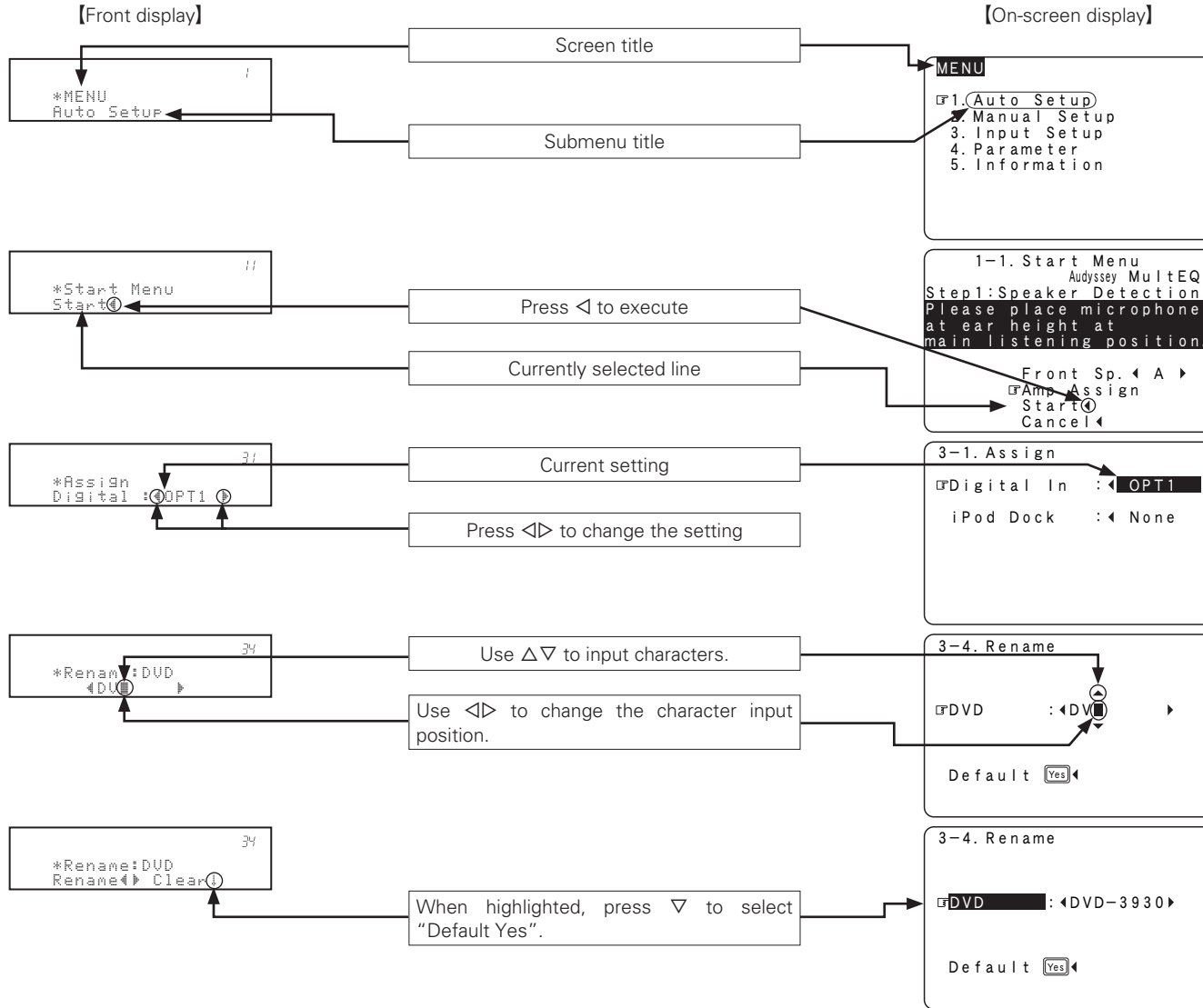

The selected setup menu number is shown in the master volume indicator section of the display.

# Menu Map

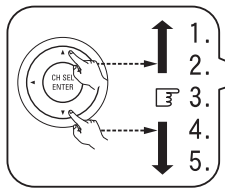

**MENU**

1. Auto Setup
2. Manual Setup
3. Input Setup
4. Parameter
5. Information

**Auto Setup** (page 25 ~ 29)

- Start Menu
  - Step 1: Speaker Detection
  - Step 2: Measurement
  - Step 3: Calculation
  - Step 4: Check
  - Step 5: Store
- Parameter Check
  - Speaker Configuration Check
  - Distance Check
  - Channel Level Check
  - Crossover Frequency Check
  - EQ Check
  - Restore

**Manual Setup** (page 29 ~ 37)

- Speaker Setup (page 29 ~ 31)
  - Speaker Configuration
  - Subwoofer Setup
  - Distance
  - Channel Level
  - Crossover Frequency
  - Front Speaker Setup
- Audio Setup (page 33, 34)
  - EXT. IN Subwoofer Level
  - 2ch Direct/Stereo
  - Dolby Digital Setup
  - Auto Surround Mode
  - EQ Preset
- ZONE2 Setup (page 34, 35)
  - Level Lch
  - Level Rch
  - Volume Limit
  - Power On Level
  - Mute Level
- Option Setup (page 35 ~ 37)
  - Amp Assign
  - Volume Control
  - Source Delete
  - On-Screen Display
  - Quick Select Name
  - Remote ID Setup
  - 2Way Remote
  - Display
  - Setup Lock

**Information** (page 52, 53)

- Status
  - MAIN ZONE
  - ZONE2
- Audio Input Signal
- HDMI Information
- Auto Surround Mode
- Quick Select
- Preset Station

**Parameter** (page 46 ~ 51)

- Surround Parameter
  - Mode
  - Cinema EQ
  - DRC
  - Dynamic Range Compression
  - LFE
  - Center Image
  - Panorama
  - Dimension
  - Center Width
  - Delay Time
  - Effect Level
  - Room Size
  - AFDM
  - SB CH Out
  - SW ATT
  - Subwoofer
  - Default
- Tone
  - Tone Control
  - Bass
  - Treble
- Audyssey Settings
  - MultEQ
  - Dynamic EQ
  - Dynamic Volume
  - Setting
- RESTORER
- Night Mode
- Audio Delay

**Input Setup** (page 38 ~ 43)

- TUNER (FM/AM)
  - Auto Preset
  - Preset Skip
  - Preset Name
  - Video
  - Input Mode
  - Rename
  - Source Level
- CD, CDR/TAPE, DVD, HDP, TV/CBL, VCR, V.AUX
  - Assign
  - Video
  - Input Mode
  - Rename
  - Source Level
  - iPod
- XM
  - Preset Skip
  - Antenna Aiming
  - Video
  - Input Mode
  - Rename
  - Source Level
- SIRIUS
  - Preset Skip
  - Parental Lock
  - Antenna Aiming
  - Assign
  - Video
  - Input Mode
  - Rename
  - Source Level

When "Screensaver" is set to "ON", the screensaver is activated if no operation is performed for about 3 minutes.

When you press  $\Delta \nabla \triangleleft \triangleright$ , the screen saver is cancelled and the screen before that screen saver started is displayed.

# Auto Setup

**Symbols used to indicate buttons in this manual**

- Button located on both the main unit and the remote control unit → **BUTTON**
- Button only on the main unit → **<BUTTON>**
- Button only on the remote control unit → **[BUTTON]**

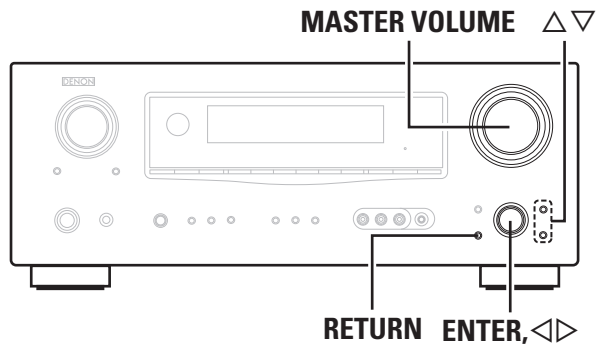

[Front]

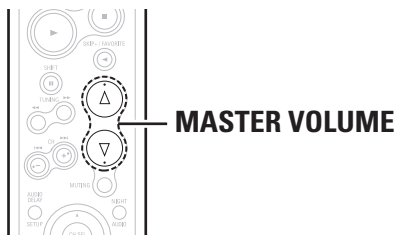

[Rear]

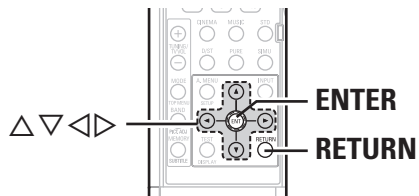

- Audyssey MultEQ® automatically measures the acoustical problems in the listening environment to create the best audio experience for your home theater.
- Audyssey MultEQ optimizes a large listening area where one or more listeners are seated. Measurements are performed by placing the calibrated microphone (DM-A409) successively at multiple positions throughout the listening area as shown in **Example ①**. For best results, it is strongly recommended to measure 6 positions so that the measurements have the proper spatial weighting. Even if the listening environment is small as shown in **Example ②**, measuring at multiple points throughout the listening environment results in more effective correction.

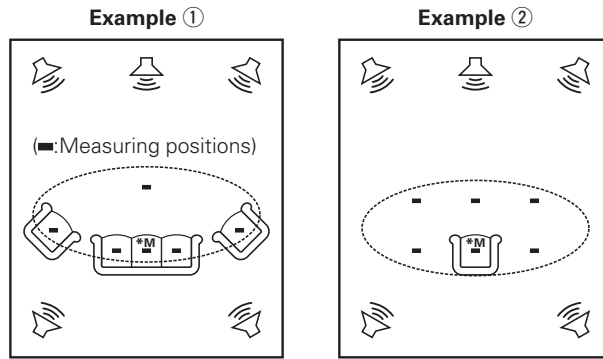

**About the main listening position (\*M)**

The main listening position refers to the most central position where one would normally sit within the listening environment. MultEQ uses the measurements from this position to calculate speaker distance, level, polarity, and the optimum crossover value for the subwoofer.

To make manual adjustments to the settings, see pages 29 ~ 31.

## Preparations

- 1 Connect the included calibrated setup microphone to the SETUP MIC jack on the main unit.**  
The auto setup screen appears automatically.

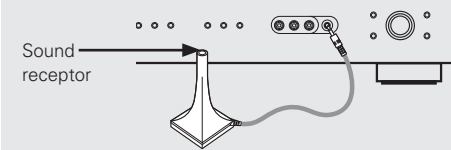

- 2 Place the microphone at ear height on a tripod or stand with the microphone pointing directly up towards the ceiling.**

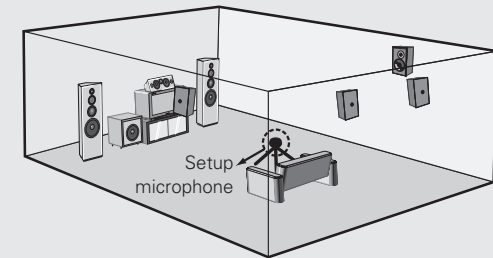

※ Do not hold the microphone in your hand during measurements. Be sure that the path from microphone to the speakers is not blocked by objects. Avoid placing the microphone close to a seat back or wall as sound reflections may give inaccurate results.

When using a subwoofer, make the following settings before starting the auto setup procedure:

- Defeat the volume and crossover controls if possible
- If this is not possible then set
  - Volume: "12 o'clock" position
  - Crossover frequency: "Maximum/Highest Frequency"
  - Low pass filter: "Off"
  - Standby mode: "Off"

**NOTE**

- Do not disconnect the setup microphone until the auto setup procedure is completed.
- When using headphones, unplug the headphones before starting the auto setup procedure.

## Auto Setup

Optimize settings for speakers in use.

### 1 Start Menu

The settings found at this stage are applied automatically.

[Auto setup flow]

**Step 1: Speaker Detection**

**Step 2: Measurement**

**Step 3: Calculation**

**Step 4: Check**

**Step 5: Store**

**NOTE**

- Loud test sounds may be played during Audyssey MultEQ automatic speaker setup. This is part of normal operation. If there is background noise in room, these test signals will increase in volume.
- Do not stand between the speakers and setup microphone or allow obstacles in the path while the measurements are being made. This will cause inaccurate readings.
- Make the room as quiet as possible. Background noise can disrupt the room measurements. Close windows, silence cell phones, televisions, radios, air conditioners, fluorescent lights, home appliances, light dimmers, or other devices as measurements may be affected by these sounds. Cell phones should be placed away from all audio electronics during the measurement process as Radio Frequency Interference (RFI) may cause measurement disruptions (even if the cell phone is not in use).
- Operating **MASTER VOLUME** during the measurements will cancel the measurements.

### About the Auto Setup

The Audyssey MultEQ auto setup function detects the presence of each speaker and automatically calculates the speaker size, channel level, distance, and optimal crossover frequency setting. Audyssey MultEQ corrects acoustical distortions within the listening area. Before starting, connect and position all of your speakers. Once started, MultEQ will play a series of test tones through each speaker.



If an error message appears during the measurements, check "Error Messages", take the advised action, then start the measurements again (page 28).

**Front Speaker**

The front speaker to be measured can be selected ahead of time here.

[Selectable items]

- A** : Output test tone from front speakers A.
- B** : Output test tone from front speakers B.
- A+B** : Output test tone from front speakers A and B.

**Amp Assign**

Advanced setting : changes power amplifier assignment. For details, refer to "Amp Assign" (page 35).

### Step 1 : Speaker Detection

● **Menu screen** ●

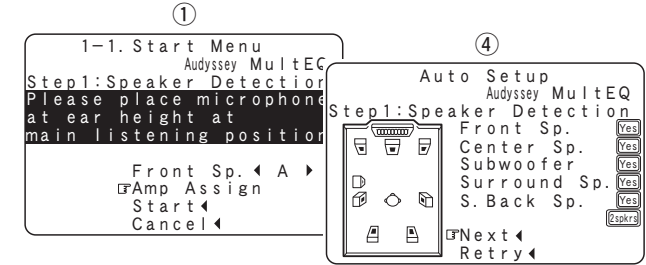

The speaker connection and polarity are detected at the first measurement position (main listening position). The following attributes are also determined at this time: "Speaker Size", "Speaker Distance", "Channel Level", "Crossover Frequency".

- ① Press  $\Delta \nabla$  to select "Amp Assign", then press **ENTER**.
- ② Press  $\triangleleft \triangleright$  to select "7.1ch", then press **ENTER**.
- ③ Press  $\Delta \nabla$  to select "Start <", then press  $\triangleleft$ .
- ④ Press  $\Delta \nabla$  to select "Next <", then press  $\triangleleft$ .

- To cancel the measurements, press  $\triangleleft$ .



- If the result differs from the actual connection status or an error message appears, use  $\nabla$  to on-screen display "Retry <" and then press  $\triangleleft$  to repeat the measurement.
- If the result still differs from the actual connection status after re-measurement or the error message still appears, it is possible that the speakers are not connected properly. Turn the AVR-1909 off, check the speaker connections and repeat the measurement process from the beginning.

**NOTE**

Do not change the speaker connections or subwoofer volume after "Step 1".



**Step 2 : Measurement**

● Menu screen ●

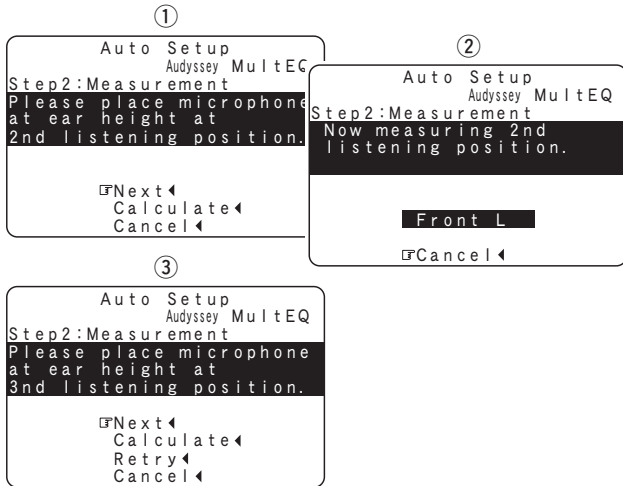

- ① Press  $\Delta$  to select "Next ◀", then press  $\triangleleft$ .
  - The measurement of the 2nd position starts.
- ② Move the microphone to the 3rd position and press  $\triangleleft$ .
  - The measurement of the 3rd position starts.
- ③ Perform ② repeatedly for the 4th, 5th, and 6th measurements.
  - "All the measurements were finished." is displayed on the on-screen display. When you have completed measurements in 6 positions.
  - If you want to stop after measuring just five or fewer positions, press  $\nabla$  to select "Cancel ◀", then press  $\triangleleft$ .



After completing a measurement position, move the microphone to the next position.  
 Measure at 6 positions: the main listening position and 5 other surrounding positions. Although it is allowable to measure less than 6 positions, it is recommended to measure **6** for best results.

**Step 3 : Calculation**

● Menu screen ●

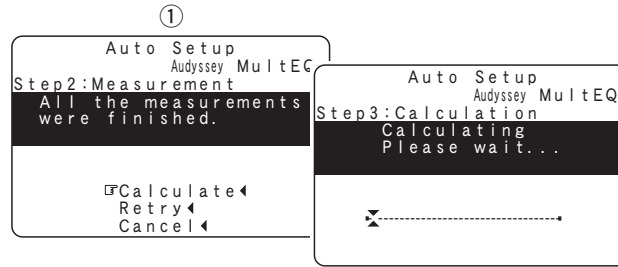

The values obtained from the measurements are automatically analyzed and the attributes for each of the speakers in the listening area are determined.

- ① Press  $\Delta$  to select "Calculate ◀", then press  $\triangleleft$ .
  - Analysis begins.



- Analysis takes several minutes to complete.
- The time required for this analysis depends on the number of speakers connected. The greater the number of speakers connected, the longer analysis will take.

**NOTE**

- Do not change the speaker connections or subwoofer volume, or speaker locations after making measurements. If changes are necessary, make the changes and use the Audyssey MultEQ auto setup once again for an updated EQ solution.
- For instance, if the location or direction of a speaker is altered, the Auto Setup should be performed again to ensure the correct EQ solution for the new room configuration.

**Step 4 : Check**

● Menu screen ●

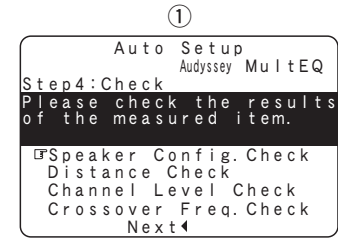

When analysis is complete, check the analysis results for the following four items.

- ① Make your selection using  $\Delta/\nabla$  and press **ENTER**.
  - Presence and size of speaker  
"Speaker Config. Check"
  - Distance of speaker from listening position  
"Distance Check"
  - Speaker channel level  
"Channel Level Check"
  - Crossover Frequency  
"Crossover Freq. Check"
- ② Use  $\Delta/\nabla$  to change which speaker is displayed.

**To switch to another analysis result item**

Press **RETURN**.  
 This returns you to analysis results items, so repeat step ①.

**To proceed to "Step 5 : Store"**

Press  $\Delta$  to select "Next ◀", then press  $\triangleleft$ .



Distance values that are greater than the actual distance of a speaker may be accurate for speakers with built-in filters (subwoofers, etc). This is because these filters add electrical delay (distance) to the signal that is compensated for by the Auto Setup process.

**Step 5 : Store**

● **Menu screen** ●

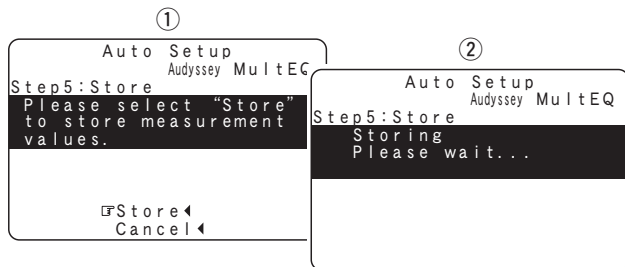

The auto setup measurement results are stored in the AVR-1909.

- ① Press  $\Delta$  to select "Store  $\blacktriangleleft$ ", then press  $\blacktriangleleft$ .
  - "Storing Please wait..." is displayed on the on-screen display while the results are being stored.
  - When storing is complete, "Storing complete. Auto Setup is now finished." is displayed on the on-screen display.
- ② Select "Exit", then press **ENTER**.
- ③ Disconnect the setup microphone from the AVR-1909.

□ **To cancel storing**

- Press  $\Delta \nabla$  to select "Cancel  $\blacktriangleleft$ ", then press  $\blacktriangleleft$ .
- All the measured auto setup data will be erased.

**NOTE**

Do not turn the power off while the settings are being stored.

**Error Messages**

If the auto setup procedure could not be completed due to speaker installation, the measuring environment, etc., an error message is displayed. If this happens, check the relevant items, be sure to take the necessary measures, then perform the auto setup procedure over again.

Error messages (examples)	Cause	Measures
	<ul style="list-style-type: none"> <li>• Included setup microphone is not connected.</li> <li>• Not all speakers could be detected.</li> <li>• The front L speaker was not properly detected.</li> </ul>	<ul style="list-style-type: none"> <li>• Connect the included setup microphone to the <b>SETUP MIC</b> jack on the main unit.</li> <li>• Check the speaker connections.</li> </ul>
	<ul style="list-style-type: none"> <li>• Too much noise in the room for accurate measurements to be made.</li> <li>• Speaker or subwoofer sound is too low for accurate measurements to be made.</li> </ul>	<ul style="list-style-type: none"> <li>• Either turn off any device generating noise or move it away.</li> <li>• Try again when the surroundings are quieter.</li> <li>• Check the speaker installation and the direction in which the speakers are facing.</li> <li>• Adjust the subwoofer's volume.</li> </ul>
	<ul style="list-style-type: none"> <li>• Displayed speaker could not be detected.                             <ul style="list-style-type: none"> <li>· The front R speaker were not properly detected.</li> <li>· Only one channel of the surround speakers was detected.</li> <li>· Sound was output from the R channel when only one surround back speaker was connected.</li> <li>· The surround back, but the surround speaker was not detected.</li> </ul> </li> </ul>	<ul style="list-style-type: none"> <li>• Check the connections of the displayed speaker.</li> </ul>
	<ul style="list-style-type: none"> <li>• Displayed speaker connected with the polarities reversed.</li> </ul>	<ul style="list-style-type: none"> <li>• Check the polarities of the displayed speaker.</li> <li>• For some speakers, this error message may be displayed even if the speaker is properly connected. If you are sure that the wiring is correct, select "Skip".</li> </ul>

Select "Retry" to measure again.

**NOTE** Be sure to turn the power off before checking the speaker connections.

## 2 Parameter Check

Check auto setup measurement results.  
This is displayed after the auto setup procedure is completed.

### [Selectable items]

Speaker Config. Check	Distance Check
Channel Level Check	Crossover Freq. Check
EQ Check	



The auto setup results can be set again when "Restore" is selected.

# Manual Setup



### Symbols used to indicate buttons in this manual

- Button located on both the main unit and the remote control unit → **BUTTON**
- Button only on the main unit → **<BUTTON>**
- Button only on the remote control unit → **[BUTTON]**

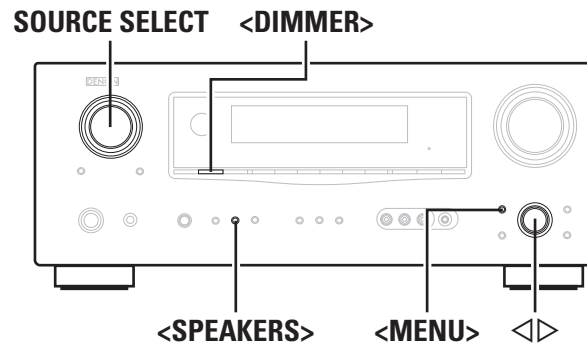

[Front]

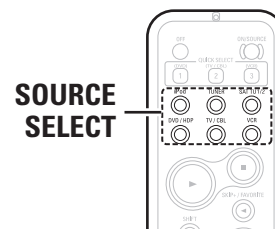

[Rear]

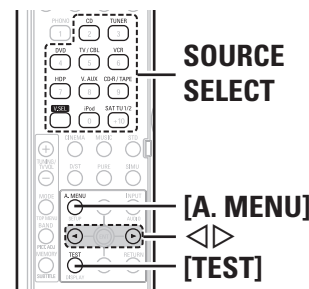

Make detail settings for various parameters.

## Speaker Setup

Use this procedure to set the speakers manually or if you wish to change the settings made with the auto setup procedure.

### ● Menu screen ●

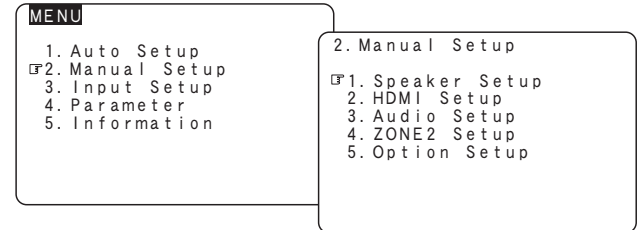

## 1 Speaker Configuration

Select speaker configuration and size.  
(bass reproduction capability)

### Front Speaker

Select front speaker size.

[Selectable items] **Large** **Small**

### Center Speaker

Select center speaker use and size.

[Selectable items] **Large** **Small** **None**

### Subwoofer

Select subwoofer use.

[Selectable items] **Yes** **No**

## Surround Speaker

Select surround speakers use and size.

[Selectable items] **Large** **Small** **None**

## Surround Back Speaker

Select surround back speaker use and size.

[Selectable items] (**Large** **Small** **None**)  
(**2spkrs** **1spkr**)

### NOTE

Since "Amp Assign" of AVR-1909 is set to "ZONE2" by default, audio is not output from the surround back speakers. When using the surround back speakers with MAIN ZONE, change the "Amp Assign" setting to "7.1ch" (🔧 page 35).

**Large** :Select this when using large speakers with ample low frequency reproduction capabilities.

**Small** :Select this when using small speakers without ample low frequency reproduction capabilities.

**None** :Select this when no speaker is connected.

**Yes** :Select this when a subwoofer is connected.

**No** :Select this when no subwoofer is connected.

**2spkrs** **1spkr** :

Select the number of surround back speakers.

**Even when the Surround Back Speaker setting is other than "None", sound may not be emitted from the surround back speaker, depending on the playback source. In this case, make a menu "Parameter" – "Surround Parameter" – "SB CH Out" setting other than "OFF" (🔧 page 48).**



- Select "Large" or "Small" not according to the physical size of the speaker but according to the low frequency reproduction capabilities based on the frequency set at "Crossover Frequency" (🔧 page 31).
- When "Front Speaker" is set to "Small", "Subwoofer" can automatically set to "Yes".
- If "Subwoofer" is set to "No", "Front Speaker" is automatically set to "Large".
- If "Surround Speaker" is set to "None", "Surround Back Speaker" are automatically set to "None".
- When "Front Speaker" is set to "Small", "Center Speaker" can not be set to "Large".
- When using just one surround back speaker, connect it to the left channel (SBL).

## 2 Subwoofer Setup

Select low range signal to be reproduced by subwoofer.

[Selectable items]

**LFE** :Play low range and LFE signal of channels set to "Small".

**LFE+Main** :Play low range and LFE signal of all channels.



- This can be set when menu "Speaker Configuration" – "Subwoofer" is set to "Yes".
- Play music or a movie source and select the mode offering the strongest bass.
- Select "LFE+Main" if you want the bass signals to always be produced from the subwoofer.

## 3 Distance

Set distance from listening position to speakers.  
Before making the settings, measure the distance from the listening position to the different speakers.

### Feet / Meters

Select unit for distance.

### Step

Select step. (smallest distance)

[Selectable items]

**1ft** **0.1ft** : Can be selected when "Feet" is set.

**0.1m** **0.01m** : Can be selected when "Meters" is set.

### Default

Resets the settings to the default values.

### Distance measurement

Select the speaker you want to set, then set the distance.  
Set the value closest to the measured distance.

[Variable range]

**0.0ft ~ 60.0ft** : Display when "Feet" is set.

**0.00m ~ 18.00m** : Display when "Meters" is set.

### NOTE

Set the distance between the listening position and the various speakers to no more than 20.0 ft (6.00 meters).

## 4 Channel Level

Adjust channel levels to obtain equal volume from all speakers.

### Test Tone

Select test tone playback method.

#### [Selectable items]

**Auto** : Automatically switch speaker from which test tone is output.

**Manual** : Manually switch speaker from which test tone is output.

### Test Tone Start

Output test tone.

[Variable range] **OFF** \* ~ **-12dB** ~ **0dB** ~ **+12dB**

\* In the case of a sub woofer, reducing the volume when it is at “-12 dB” will change the setting to “OFF” (none).

### Default

Resets the settings to the default values.



### Operating from the main remote control unit

Adjusting with the main remote control unit using the test tones is only possible in the “Auto” mode and only effective in the STANDARD mode. The adjusted levels for the different modes are automatically stored in the memory.

#### [Adjusting using test tones]

① Press **[TEST]**.

Test tones are output from the various speakers.

② Use <|> to adjust so that the volume is equal for all speakers.

③ When the adjustments are completed, press **[TEST]** again.



- When the menu “Speaker Configuration” – “Surround Back Speaker” setting (page 30) is set to “1spkr”, the surround back speaker display is set to “Surround Back Sp.”.
- Speakers set to “None” in the “Speaker Configuration” settings are not displayed.
- When “Channel Level” is adjusted, the adjusted values are set for all the surround modes. To adjust the channel level separately for the different surround modes, use the operation see page 63.

## 5 Crossover Frequency

Select crossover frequency from which subwoofer handles low range signal.

#### [Selectable items]

**40Hz** **60Hz** **80Hz** **90Hz** **100Hz** **110Hz** **120Hz** **150Hz**  
**200Hz** **250Hz** :

Only the portion of the bass sound of the various speakers output from the subwoofer that has a frequency below the frequency set here is output.

Set this according to the low frequency reproduction capabilities of the speakers you are using.

#### Advanced :

Set the crossover frequency separately for the different speakers.



- If in the “Advanced” settings, “Subwoofer Setup” (page 30) in the menu is set to “LFE”, it is possible to make this setting for speakers set to “Small” at “Speaker Configuration”. If set to “LFE+Main”, this setting can be made regardless of the speaker size.
- For speakers set to “Small”, sound below the crossover frequency is cut from the sound output. The cut bass sound is output from the subwoofer or front speakers.
- Always set the crossover frequency to “80 Hz”. When using small speakers, however, we recommend setting the crossover frequency to a higher frequency.

## 6 Front Speaker Setup

Select front speakers to use for each surround mode.

#### [Selectable items]

**Normal** : To change the settings, select “Custom”.

**Custom** : Make separate settings for 2-channel mode.

When set to “Custom”, you can select beforehand the front speaker to use for each surround mode.

#### [Selectable items]

DIRECT/STEREO : **A** **B** **A+B**

MULTI CH : **A** **B** **A+B**

#### NOTE

When set to “Custom”, <SPEAKERS> does not operate.

# HDMI Setup

Make settings for HDMI video/audio output.

## ● Menu screen ●

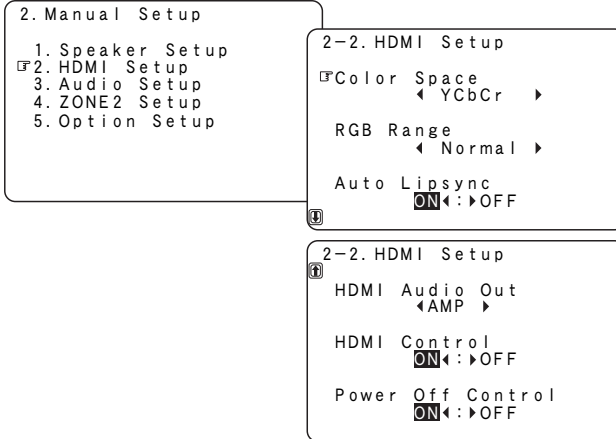

## 1 Color Space

Make settings for output color space.

### [Selectable items]

**YCbCr** : Output using YCbCr format.

**RGB** : Output using RGB format.



When connected to a monitor with a DVI-D connector (HDCP compatible) using an HDMI/DVI converter cable, the signals are output in RGB format, regardless of this setting.

## 2 RGB Range

Make settings for RGB output range.

### [Selectable items]

**Normal** : Use video range from 16 (black) to 235 (white).

**Enhanced** : Video range from 0 (black) to 255 (white). Use this setting to avoid black washout.



When "YCbCr" is selected under "Color Space", "RGB Range" will have no effect.

## 3 Auto Lipsync

Automatic compensation for timing shift in audio and video output.

[Selectable items] **ON** **OFF**

## 4 HDMI Audio Out

Select HDMI audio output device.

### [Selectable items]

**AMP** : Use speakers connected to receiver for audio playback.

**TV** : Use speakers of TV for audio playback.

### NOTE

When the HDMI control function is operating, the setting of audio playback in the connected TV takes priority (page 62 "HDMI Control Function").

## 5 HDMI Control

Make settings for HDMI control function.

[Selectable items] **ON** **OFF**



Please consult the operating instructions for each connected device to check the settings.

### NOTE

For details, see "HDMI Control Function" (page 62).

## 6 Power Off Control

Interlock power OFF with HDMI control.

[Selectable items] **ON** **OFF**



- This can be set when "HDMI Control" is set to "ON".
- Please consult the operating instructions for each connected device to check the settings.

### NOTE

- When the "HDMI Control" setting has been changed, always turn off the power to the connecting devices afterwards and then turn back on.
- The "HDMI Control" and "Power Off Control" does not work when the power to the equipment is off.
- For details, see "HDMI Control Function" (page 62).

# Audio Setup

Make settings for audio playback.

## ● Menu screen ●

### 2. Manual Setup

- 1. Speaker Setup
- 2. HDMI Setup
- 3. Audio Setup
- 4. ZONE2 Setup
- 5. Option Setup

### 2-3. Audio Setup

- 1. EXT. IN SW Level
- 2. 2ch Direct/Stereo
- 3. Dolby Digital Setup
- 4. Auto Surround Mode
- 5. EQ Preset

## 1 EXT. IN Subwoofer Level

Set the subwoofer level for playback.

[Selectable items] **0dB** **+5dB** **+10dB** **+15dB**



We recommend setting to "+15dB".

## 2 2ch Direct/Stereo

Make speaker settings for 2-channel mode playback.

### Setting

To change the settings, select "Custom".

#### [Selectable items]

**Basic** : Use the same settings as in "Speaker Setup".

**Custom** : Make separate settings for 2-channel mode.

### Front

Select front speaker size.

#### [Selectable items]

**Large** **Small** : Select front speaker size.

### Subwoofer

Select subwoofer use.

#### [Selectable items]

**Yes** **No** : Select subwoofer use.

### Subwoofer Mode

Select low range signal to be reproduced by subwoofer.

#### [Selectable items]

**LFE** **LFE+Main** : Select subwoofer signal.

### Crossover

Select crossover frequency from which subwoofer handles low range signal.

#### [Selectable items]

**40Hz** **60Hz** **80Hz** **90Hz** **100Hz** **110Hz** **120Hz** **150Hz**  
**200Hz** **250Hz** : Select crossover frequency.

### Distance FL

Set distance from listening position to front left speaker.

[Variable range] **0.0ft ~ 60.0ft**

### Distance FR

Set distance from listening position to front right speaker.

[Variable range] **0.0ft ~ 60.0ft**

#### NOTE

Set the distance between the listening position and the various speakers to no more than 20.0 ft (6.00 meters).

## 3 Dolby Digital Setup

Set dynamic range for downmix playback of Dolby Digital sources.

#### [Selectable items]

**ON** : Compression is used. Select this if sound from front speakers is distorted.

**OFF** : Do not use compression. This is the recommended setting.



- Set this to "ON" if the sound from the front speakers seems distorted.
- When not using the center speaker or surround speakers, the playback sound is down-mixed and output from the front speakers.

## 4 Auto Surround Mode

Make setting for memorizing surround mode setting for each input signal type.

#### [Selectable items]

**ON** : Memorize settings. Most recently stored surround mode is automatically selected.

**OFF** : Do not memorize settings. Surround mode does not change according to input signal.



- The auto surround mode function lets you store in the memory the surround mode last used for playing the four types of input signals listed below.
  - ① Analog and PCM 2-channel signals
  - ② Dolby Digital and DTS 2-channel signals
  - ③ Dolby Digital and DTS multi-channel signals
  - ④ Multi-channel signals other than Dolby Digital and DTS (PCM, etc.)
- When playing in the PURE DIRECT mode, the surround mode does not change even if the input signal is changed.



## 5 EQ Preset

Set MultEQ related settings and Manual EQ beforehand.

### EQ Customize

When MultEQ® and Manual EQ you are not using are preset, MultiEQ can be skipped when selected on the main unit or main remote control unit.

#### Before running Auto Setup

[Selectable items]

Manual :  Used  Not Used

#### After running Auto Setup

[Selectable items]

Audyssey Byp. L/R :  Used  Not Used

Audyssey Flat :  Used  Not Used

Manual :  Used  Not Used

### Direct Mode

Select "MultEQ" use for DIRECT or PURE DIRECT mode.

[Selectable items]

ON : Use "MultEQ".

OFF : Do not use "MultEQ".

### Manual EQ

Adjust tonal quality for each speaker using graphic equalizer.

#### Default

Resets the settings to the default values.

#### Base Curve Copy

Copy the MultEQ "Audyssey Flat" correction curve.

[Selectable items]

Yes  No



"Base Curve Copy" is displayed after the auto setup procedure has been performed.

#### Adjust CH

① Select speaker adjustment method.

[Selectable items]

Each CH : Adjust tonal quality for each speaker separately.

L/R CH : Adjust tonal quality for each L/R speaker pair.

All CH : Adjust tonal quality for all speakers together.

② Select the speaker and frequency band and adjust the level.

[Selectable items]  63Hz  125Hz  250Hz  500Hz  1kHz

2kHz  4kHz  8kHz  16kHz

[Variable range]  -20dB ~  0dB ~  +6dB

## ZONE2 Setup

Make settings for audio playback in a ZONE2 system.

### ● Menu screen ●

2. Manual Setup

1. Speaker Setup  
2. HDMI Setup  
3. Audio Setup  
4. ZONE2 Setup  
5. Option Setup

2-4. ZONE2 Setup

Level Lch : ◀ 0dB ▶  
Rch : ◀ 0dB ▶  
Vol. Limit : ◀ OFF ▶  
Power On Lev. : Last ▶  
Mute Lev. : ◀ Full ▶

### NOTE

"ZONE2 Setup" is displayed when ZONE2 is selected with "Amp Assign" (👉 page 35).

### 1 Level Lch

Adjust the left channel output level.

[Variable range]  -12dB ~  0dB ~  +12dB

### 2 Level Rch

Adjust the right channel output level.

[Variable range]  -12dB ~  0dB ~  +12dB

**3 Volume Limit**

Make a setting for maximum volume.

**[Selectable items]**

- OFF** : Do not set a maximum volume.
- 20dB** : Set the maximum volume to -20 dB.
- 10dB** : Set the maximum volume to -10 dB.
- 0dB** : Set the maximum volume to 0 dB.

**4 Power On Level**

Define the volume setting that is active when the power is turned on.

**[Selectable items]**

- Last** : Use the memorized setting from the last session.
- : Always use the muting on condition when power is turned on.

**[Variable range]**

- 70dB ~ +18dB** : Set the volume level when the power is turned on in units of 1 dB.

**5 Mute Level**

Set the amount of attenuation when muting is on.

**[Selectable items]**

- Full** : The sound is cut off entirely.
- 40dB** : The sound is attenuated by 40 dB.
- 20dB** : The sound is attenuated by 20 dB.

**Option Setup**

Make various other settings.

**● Menu screen ●**

2. Manual Setup
- 1. Speaker Setup
  - 2. HDMI Setup
  - 3. Audio Setup
  - 4. ZONE2 Setup
  - 5. Option Setup
- 2-5. Option Setup
- 1. Amp Assign
  - 2. Vol. Control
  - 3. Source Delete
  - 4. On-Screen Display
  - 5. Quick Select Name
  - 6. Remote ID Setup
  - 7. 2Way Remote
  - 8. Display
  - 9. Setup Lock

**1 Amp Assign**

Define how the amplifier for the surround back speaker channels is used.

The places where the surround back amplifier are used can be set freely according to the usage environment. This makes it possible to output sound to rooms other than the room (the MAIN ZONE) where surround playback is performed (multi-zone playback) or play the sound with high quality using the front speakers (bi-amp connections).

**[Selectable items]**

- 7.1ch** : The surround back channel is output from the speakers connected to the SURR.BACK/AMP ASSIGN terminals.

- ZONE2** : When ZONE2 power is on, the ZONE2 channel is output from speakers connected to the SURR.BACK/AMP ASSIGN terminals.

- FrontA Bi-Amp** : The Front A channel for Bi-Amp use is output from the speakers connected to the SURR.BACK/AMP ASSIGN terminals.

- FrontB Bi-Amp** : The Front B channel for Bi-Amp use is output from the speakers connected to the SURR.BACK/AMP ASSIGN terminals.



For details, see "Amp Assign / Multi-zone Connections and Operations" (page 69 ~ 72).

**2 Volume Control**

Set the MAIN ZONE volume setting.

**Volume Limit**

Make a setting for maximum volume.

**[Selectable items]**

- OFF** : Do not set a maximum volume.
- 20dB** : Set the maximum volume to -20 dB.
- 10dB** : Set the maximum volume to -10 dB.
- 0dB** : Set the maximum volume to 0 dB.

**Power On Level**

This sets the volume set when the MAIN ZONE's power is turned on.

**[Selectable items]**

- Last** : Use the memorized setting from the last session.
- : Always use the muting on condition when power is turned on.

**[Variable range]**

- 80dB ~ +18dB** : Set the volume level when the power is turned on in units of 1 dB.

**Mute Level**

This sets the amount of attenuation of the volume when the mute mode is set in the MAIN ZONE.

**[Selectable items]**

- Full** : The sound is cut off entirely.
- 40dB** : The sound is attenuated by 40 dB.
- 20dB** : The sound is attenuated by 20 dB.

**3 Source Delete**

Remove input sources that are not used from the display.

**[Selectable items]**

**ON** : Use this source.

**Delete** : Do not use this source.

**Default**

Resets the settings to the default values.

**NOTE**

- Input sources being used in the various zones cannot be deleted.
- Input sources set to "Delete" cannot be selected using **SOURCE SELECT**.

**4 On-Screen Display**

Make on-screen display related settings.

**Screensaver**

Make screensaver settings.

Use the screensaver to prevent burn-in on the monitor screen.

When set to "ON", the screensaver is activated if there is no activity for about 3 minutes.

**[Selectable items]**

**ON** : Activate the screensaver if there is no activity for about 3 minutes.

**OFF** : Turn the screensaver function off.

**Text**

Input source and mode display.

**[Selectable items]**

**ON** : Turn display on.

**OFF** : Turn display off.

**Master Volume**

Master volume display during adjustment.

**[Selectable items]**

**ON** : Turn display on.

**OFF** : Turn display off.

**Tuner Information**

This sets the time the on-screen display is displayed when a tuner operation is performed.

**[Selectable items]**

**Always** : Show display continuously.

**30sec** : Show display for 30 seconds after operation.

**10sec** : Show display for 10 seconds after operation.

**OFF** : Turn display off.

**iPod Information**

This sets the time the on-screen display is displayed when an iPod operation is performed.

**[Selectable items]**

**Always** : Show display continuously.

**30sec** : Show display for 30 seconds after operation.

**10sec** : Show display for 10 seconds after operation.

**OFF** : Turn display off.

**Display Mode**

Select the on-screen display's display mode.

**[Selectable items]**

**Mode1** : If there is no video signal, flickering of the on-screen display is not prevented.

**Mode2** : Prevents flickering of the on-screen display when there is no video signal.  
Use this mode if the on-screen display does not appear in the Mode 1, as may happen according to the TV being used.

**5 Quick Select Name**

Change the Quick Select name.

Up to 16 characters can be input.

**[Input characters]**

**A~Z a~z 0~9 !#%&'()\*+,-./:;="?@[\\](space)**

**Default**

Resets the settings to the default values.

**6 Remote ID Setup**

Set remote control ID.

**[Selectable items]**

**1 2 3 4**

**NOTE**

**When using the AVR-1909 with only the included remote control unit (RC-1099), use Remote ID "1" (default).**

When using a separately sold remote control unit (RC-7000CI, etc.), this function can be used. Match the ID setting of the remote control unit and the receiver.

**7 2Way Remote**

Make setting for 2-way remote control unit.

**[Selectable items]**

**Used** : Use 2-way remote control.

**Not Used** : Do not use 2-way remote control.



When using a 2-way remote control unit (RC-7000CI and RC-7001RCI, sold separately), set this to "Used".

**8 Display**

Adjust display brightness of the receiver.

**[Selectable items]**

- Bright** : Normal display brightness.  
**Dim** : Reduced display brightness.  
**Dark** : Very low display brightness.  
**OFF** : Display is off unless controls are operated.

**Operating from the main unit**

Press **<DIMMER>**.



When setting to "OFF", the display brightness of the menu setting in operation changes to "Dark".

**9 Setup Lock**

Protect settings from inadvertent change.

**[Selectable items]**

- ON** : Turn protection on.  
**OFF** : Turn protection off.



- When "Setup Lock" is set to "ON", the settings listed below can no longer be changed. Also, "SETUP LOCKED!" is displayed if you attempt to operate related buttons.
  - RESTORER
  - Night Mode
  - Parameter
  - MultEQ
  - Dynamic EQ
  - Dynamic Volume
  - Channel Level
  - Audio Delay
- To cancel the setting, press **<MENU>** or **[A.MENU]** to re-display the "Setup Lock" screen, then change the setting to "OFF".

# Input Setup

**Symbols used to indicate buttons in this manual**

- Button located on both the main unit and the remote control unit → **BUTTON**
- Button only on the main unit → **<BUTTON>**
- Button only on the remote control unit → **[BUTTON]**

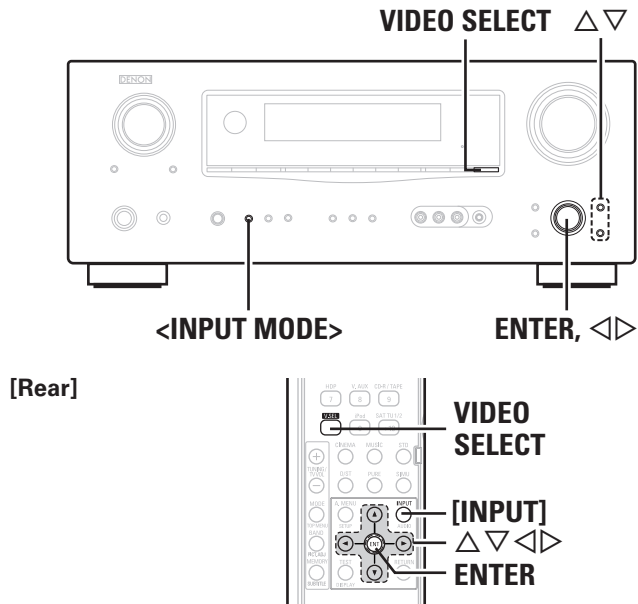

Use this procedure to select the input source and make the settings related to playing input sources.

## ❑ TUNER (AM/FM)

This menu is for "TUNER".

### ● Menu screen ●

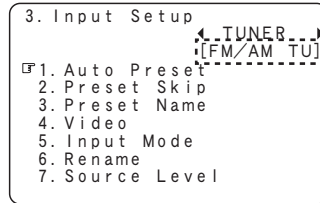

## ❑ XM

This menu is for "XM".

### ● Menu screen ●

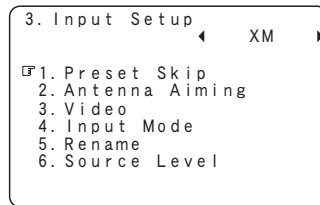

## ❑ SIRIUS

This menu is for "SIRIUS".

### ● Menu screen ●

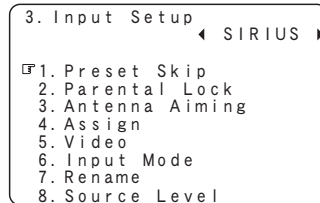

## ❑ CD, CDR/TAPE, DVD, HDP, TV/CBL, VCR, V.AUX

This menu is for "CD", "CDR/TAPE", "DVD", "HDP", "TV/CBL", "VCR", "V.AUX".

### ● Menu screen ●

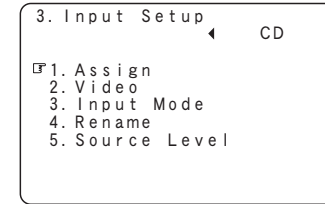

※ The menu settings below can be made for these input sources when "iPod dock" is set to "Assign".

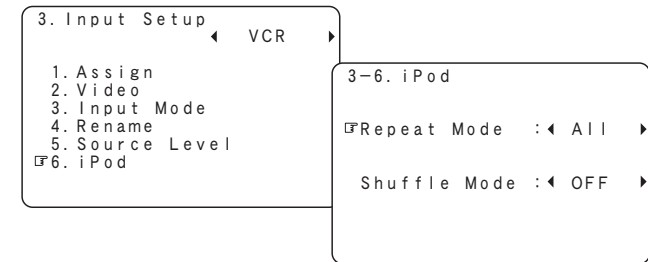

## Changing the input source within Input Setup

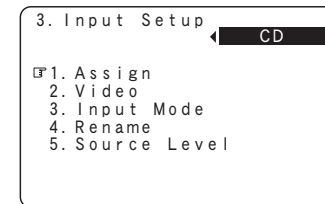

The input source currently selected in the MAIN ZONE is not changed even when the input source within Input Setup is changed.

## Settings Related to Playing Input Sources

### 1 Auto Preset

Use the auto preset function to program radio stations.

[Input source] **TUNER**

#### [Selectable items]

**Start** : Start the auto preset process.



If an FM station cannot be preset automatically, select the desired station by tuning it in manually, then preset it manually.

### 2 Preset Skip

Set the preset memories that you do not want to display when tuning.

#### A ~ G

Select the preset channel(s) you do not want to display.

[Input source] **TUNER** **XM** **SIRIUS**

#### [Selectable items]

**ON** : Display this number.

**Skip** : Skip this number.



When set to "Skip", it is possible to skip entire preset memory blocks (A to G).

### 3 Preset Name

Assign name to a preset memory.  
Names containing up to 8 characters can be input.

#### A1 ~ G8

Select the preset memory number.

[Input source] **TUNER**

#### [Characters that can be input]

**A ~ Z** **a ~ z** **0 ~ 9** **! # % & ' ( ) \* + , - . / : ; = " ? @ [ \ ] (space)**

### 4 Video

Setting the video source.

#### Video Select

Switch video input source while listening to audio signal.

[Input source] **TUNER** **CD** **CDR/TAPE** **DVD** **HDP**  
**TV/CBL** **VCR** **V.AUX** **XM** **SIRIUS**

#### [Selectable items]

**DVD** **HDP** **TV/CBL** **VCR** **V.AUX** :

Select video input source to view.

**Source** :

The video and audio for the same input source are played.



#### Operating from the main unit or main remote control unit

Press **VIDEO SELECT** until the desired picture appears.

※ To cancel, press **VIDEO SELECT** to select "Source".

#### NOTE

- It is not possible to select HDMI input signals.
- When playing HDMI video input signals, the analog video signal of another input source cannot be selected for the HDMI video output.
- Input sources for which "Delete" is selected at "Source Delete" cannot be selected.
- When "HDP" is set to "None" with "Manual Setup" – "Input Setup" – "Amp Assign" – "Component In" from the menu, you cannot set "Video Select" to "HDP".

#### Convert

Automatically convert video input signal to monitor output format.

[Input source] **DVD** **HDP** **TV/CBL** **VCR** **V.AUX**

#### [Selectable items]

**ON** : Enable conversion.

**OFF** : Disable conversion.

#### NOTE

When a non-standard video signal from a game machine or some other source is input, the video conversion function might not operate. If this happens, please set the conversion mode to "OFF".

## i/p Scaler

Make settings for i/p scaler function.

[Input source] **DVD** **HDP** **TV/CBL** **VCR** **V.AUX**

### [Selectable items]

**A to H** : Use i/p scaler function for analog video signal.

**OFF** : Do not use i/p scaler function.

### NOTE

When the “Convert” setting is “OFF”, you cannot set “i/p scaler”.

## Resolution

Make settings for resolution of HDMI video output signal.

[Input source] **DVD** **HDP** **TV/CBL** **VCR** **V.AUX**

### [Selectable items]

**Auto** : Detect monitor panel resolution and automatically set output resolution.

**480p/576p** : Output at 480p/576p resolution.

**1080i** : Output at 1080i resolution.

**720p** : Output at 720p resolution.

**1080p** : Output at 1080p resolution.



This can be set when “i/p Scaler” is set to “A to H”.

### NOTE

- It is not possible to convert “1080i” signals into “720p” format.
- It is not possible to convert “720p” signals into “1080i” format.

## Progressive Mode

Select optimum progressive mode for video material.

[Input source] **DVD** **HDP** **TV/CBL** **VCR** **V.AUX**

### [Selectable items]

**Auto** : Automatically detect video material type.

**Video1** : Select mode suitable for video playback.

**Video2** : Select mode suitable for video and 30-frame film material playback.



This can be set when “i/p Scaler” is set to “A to H”.

## Aspect

This sets the aspect ratio when outputting 480i/576i or 480p/576p input signals from the HDMI output connector.

[Input source] **DVD** **HDP** **TV/CBL** **VCR** **V.AUX**

### [Selectable items]

**Full** : Output at 16:9 aspect ratio.

**Normal** : Output at 4:3 aspect ratio.



This can be set when “i/p Scaler” is set to “A to H”.



## 5 Input Mode

Make input mode and decode mode settings for this source. The selectable input modes depend on the input source and "Assign" setting (☞ page 42).

### Input Mode

Set the input mode for this source.

[Input source] **TUNER**

#### [Selectable items]

**Analog** : Play only signals from analog input.

**EXT. IN** : Play only signals from EXT. IN input.

[Input source] **XM**

#### [Selectable items]

**Auto** : Automatically detect input signal and perform playback.

**EXT. IN** : Play only signals from EXT. IN input.

[Input source] **CD** **CDR/TAPE** **DVD** **HDP** **TV/CBL** **VCR**  
**V.AUX** **SIRIUS**

#### [Selectable items]

**Auto** : Automatically detect input signal and perform playback.

**HDMI** \*1 : Play only signals from HDMI input. (Excluding CD and SIRIUS)

**Digital** \*2 : Play only signals from digital input.

**Analog** : Play only signals from analog input.

**EXT. IN** : Play only signals from EXT. IN input.

\*1: This can be selected for input sources for which the menu "Assign" setting is set to "HDMI In".

\*2: This can be selected for input sources for which the menu "Assign" setting is set to "Digital In" (☞ page 42).



- When a digital signal is properly input, the "DIG." indicator lights on the display. If the "DIG." indicator does not light, check the digital input connector assignment and the connections.
- The surround mode cannot be set if the input mode is set to "EXT. IN".
- Only set "PCM" and "DTS" when playing the respective signals.



### Operating from the main unit or main remote control unit

Press <INPUT MODE> or [INPUT]. Each time you press the button, the input mode display will change.



\*1: This can be selected for input sources for which the menu "Assign" setting is set to "HDMI In".

\*2: This can be selected for input sources for which the menu "Assign" setting is set to "Digital In" (☞ page 42).

### Decode Mode

Set the decode mode for this source.

[Input source] **CD** **CDR/TAPE** **DVD** **HDP** **TV/CBL** **VCR**  
**V.AUX**

#### [Selectable items]

**Auto** : Detect type of digital input signal and decode and play automatically.

**PCM** : Decode and play only PCM input signals.

**DTS** : Decode and play only DTS input signals.



- This can be selected for input sources for which the menu "Assign" setting is set to "HDMI In" or "Digital In" (☞ page 42).
- Only set "PCM" and "DTS" when playing the respective signals.

## 6 Rename

Change the display name for this source. Names containing up to 8 characters can be input.

### [Characters that can be input]

**A ~ Z** **a ~ z** **0 ~ 9** **! # % & ' ( ) \* + , - . / : ; = " ? @ [ \ ] (space)**

### Default

Resets the settings to the default values.

## 7 Source Level

Corrects the playback level of the selected input source's audio input.

[Variable range] **-12dB** ~ **0dB** ~ **+12dB**



For input sources for which "HDMI In" and "Digital In" are set at the menu "Assign" setting, the analog input level and digital input level can be set separately.

## 8 Assign

Assign input sources to input connectors.

### HDMI In

Select HDMI connector to assign to this source.

[Input source] **DVD** **HDP** **TV/CBL** **VCR** **V.AUX**

#### [Selectable items]

**HDMI1** : Assign HDMI1 input connector.

**HDMI2** : Assign HDMI2 input connector.

**HDMI3** : Assign HDMI3 input connector.

**None** : No HDMI input connector assigned.

Input source	DVD	HDP	TV/CBL	VCR	V.AUX
Default setting	<b>HDMI1</b>	<b>HDMI2</b>	None	<b>HDMI3</b>	None



- With HDMI, the video and audio signals are transferred simultaneously. When HDMI is assigned to an input source, the audio signal switches to HDMI along with the video signal. To use with the digital audio input connectors assigned, set menu "Input Mode" to "Digital".
- When the AVR-1909 and monitor are connected with an HDMI cable, if the monitor is not compatible with HDMI audio signal playback, only the video signals are output to the monitor.
- The audio signals input from the analog, digital and EXT. IN connectors are not output to the monitor.

### Digital In

Select digital input connector to assign to this source.

[Input source] **CD** **CDR/TAPE** **DVD** **HDP** **TV/CBL** **VCR**  
**V.AUX** **SIRIUS**

#### [Selectable items]

**COAX1** : Assign COAXIAL 1 input connector.

**COAX2** : Assign COAXIAL 2 input connector.

**OPT1** : Assign OPTICAL 1 input connector.

**OPT2** : Assign OPTICAL 2 input connector.

**None** : No digital input connector assigned.

Input source	CD	CDR/TAPE	DVD	HDP	TV/CBL	VCR	V.AUX	SIRIUS
Default setting	<b>COAX2</b>	None	<b>COAX1</b>	None	<b>OPT1</b>	<b>OPT2</b>	None	None

### Component In

Select component video input to assign to this source.

[Input source] **DVD** **HDP** **TV/CBL** **VCR** **V.AUX**

#### [Selectable items]

**1-RCA** : Assign component video 1 input connector.

**2-RCA** : Assign component video 2 input connector.

**3-RCA** : Assign component video 3 input connector.

**None** : No component video input connector assigned.

Input source	DVD	HDP	TV/CBL	VCR	V.AUX
Default setting	<b>1-RCA</b>	<b>2-RCA</b>	<b>3-RCA</b>	None	None

### iPod dock

Assign control dock for iPod to this source.

[Input source] **CD** **CDR/TAPE** **DVD** **HDP** **TV/CBL** **VCR**  
**V.AUX**

#### [Selectable items]

**Assign** : Assign iPod input.

**None** : Do not assign iPod input.



- With the default settings, the control dock for iPod can be used connected to the VCR (iPod) connector.
- Even if "iPod dock" is set to "Assign", if AVR-1909 and control dock for iPod are not connected, the input is used as the normal input source.

## 9 iPod

Make settings for "iPod" playback.

[Input source] **CD** **CDR/TAPE** **DVD** **HDP** **TV/CBL** **VCR**  
**V.AUX**

### Repeat

Make settings for repeat mode.

#### [Selectable items]

**All** : Repeat all songs.

**One** : Repeat the current song.

**OFF** : Cancel repeat mode.

## Shuffle

Make settings for shuffle mode.

When DENON control dock for iPod ASD-1R is connected

### [Selectable items]

**Songs** : Shuffle all songs.

**Albums** : Shuffle songs from current album only.

**OFF** : Cancel shuffle mode.

When DENON control dock for iPod ASD-3N/3W is connected

### [Selectable items]

**ON** : Shuffle mode on.

**OFF** : Cancel shuffle mode.



This can be selected for input sources for which "Assign" is assigned at the "iPod dock" setting.

## 10 Antenna Aiming

Check the XM and SIRIUS radio reception sensitivity.

[Input source] **XM** **SIRIUS**

## Satellite

Indicate satellite signal strength.

## Terrestrial

Indicate terrestrial signal strength.

XM Antenna Aiming

Display	Condition
■■■■■	Signal strength is strong
■■■■	Signal strength is good
■■■	Signal strength is marginal
■■	Signal strength is weak
■	No signal

SIRIUS Antenna Aiming

Display	Condition
■■■■■	Signal strength is excellent
■■■■	Signal strength is good
■■■	Signal strength is weak
■	No signal

## 11 Parental Lock

For any channel, set the radio reception limits.

[Input source] **SIRIUS**

### Lock Setting

Set the channel radio reception limits.

- Press **ENTER**.
- Using  $\Delta \nabla \triangleleft \triangleright$ , input the password (4 digits number) and press **ENTER**.
- Select channel by pressing  $\Delta \nabla$ , and set the lock by pressing  $\triangleleft \triangleright$ .

### [Selectable items]

**Unlock** : Do not lock selected channel(s).

**Lock** : Lock selected channel(s).

※ When a Parental Locked channel is tuned, "Code : [     ]" is displayed, then input the password.



- The default password is "0000".
- If the password is wrong, "Incorrect Code" is displayed. Input the correct password.
- While listening to the channel being played, you can also set parental lock (👉 page 59).

### NOTE

You can set "Parental Lock" when the input source is "SIRIUS".

## Edit Lock Code

Change the password.

- Press **ENTER**.
- Input old password (4 digits) using  $\Delta \nabla \triangleleft \triangleright$ , and press **ENTER**.
- Input new password (4 digits) using  $\Delta \nabla \triangleleft \triangleright$ , and press **ENTER**.
- Input new password (4 digits) again using  $\Delta \nabla \triangleleft \triangleright$ , and press **ENTER**. If the correct password is input, "Completed" is displayed, and the new password is modified.



- If the old password is incorrectly input, "Incorrect Code" is displayed, and proceed again from step ①.
- If the password input is 3 digits or less, "Input 4-digit" is displayed, and input again with a 4 digit password.
- If the new password is not correctly input, "Input Error" is displayed and the password does not change.

### NOTE

You can set "Edit Lock Code" when the input source is "SIRIUS".

# Surround Modes

**Symbols used to indicate buttons in this manual**

- Button located on both the main unit and the remote control unit → **BUTTON**
- Button only on the main unit → **<BUTTON>**
- Button only on the remote control unit → **[BUTTON]**

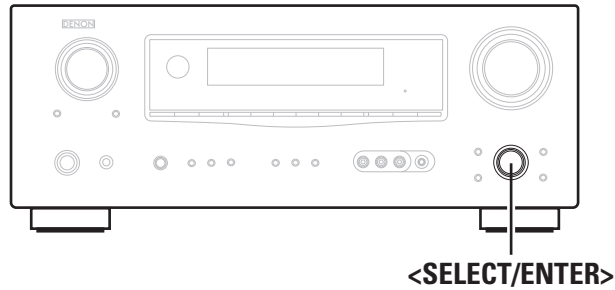

[Rear]

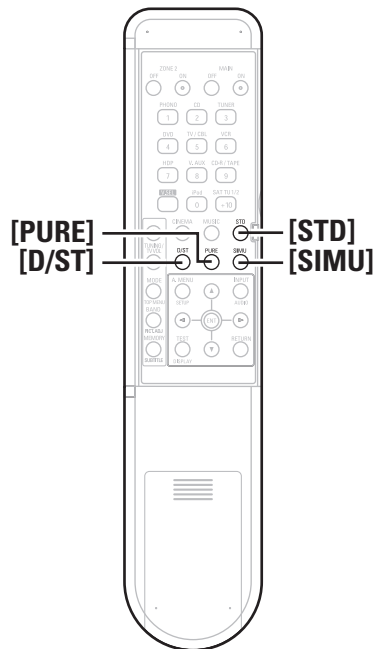

## 1 Standard Playback

This is the mode for enjoying surround sound according to the program source.

### Surround Playback of 2-channel Sources

**Selecting the surround mode**  
 Select by turning **<SELECT/ENTER>** or pressing **[STD]**.

- [Selectable items]**
- DOLBY PLIIx \* or DOLBY PLII** : The signals are decoded in DOLBY PLIIx or DOLBY PLII for playback.
  - DTS NEO:6** : The signals are decoded in DTS NEO:6 for playback.
  - neural** : It is possible to play analog input signals and PCM (2-channel, 48 kHz or less) in the surround mode. This is the optimum mode for playing sources recorded in XM HD Surround (page 75).

\* : DOLBY PLIIx can be selected when surround back speakers are being used.  
 DOLBY PLII can be selected when surround back speakers are not being used.

### Select the mode to suit the source

Select the "Cinema", "Music", "Game" and "Pro Logic" modes at menu "Parameter" – "Surround Parameter" – "Mode" (page 47).

- DOLBY PLIIx or DOLBY PLII**
  - Cinema** : This mode is suited for movie sources.
  - Music** : This mode is suited for music sources.
  - Game** : This mode is suited for games.
  - Pro Logic** : This is the Pro Logic playback mode. This can be selected when playing with a DOLBY PLII decoder. When this mode is selected, "DOLBY PL" is displayed.
- DTS NEO:6**
  - Cinema** : This mode is suited for movie sources.
  - Music** : This mode is suited for music sources.

Getting Started  
 Connections  
**Setup**  
 Playback  
 Remote Control  
 Multi-zone  
 Information  
 Troubleshooting  
 Specifications

## Playing Multi-channel Sources (Dolby Digital, DTS, etc.)

In the case of standard playback of multi channel sources, the AVR-1909 recognizes the format of the multi-channel audio input signal and automatically operates the appropriate decoder for surround sound.

### [Selectable items]

#### STANDARD :

Any of the surround modes in the “Display” column in the following table.

The mode changes depending upon factors such as the

- Input signal
- Whether or not surround back speakers are being used.

Input signal	Display
DOLBY DIGITAL (other than 2ch) / DOLBY DIGITAL EX	DOLBY DIGITAL
	DOLBY DIGITAL EX
	DOLBY DIGITAL+PLIIx CINEMA
	DOLBY DIGITAL+PLIIx MUSIC
DOLBY DIGITAL Plus (*4)	DOLBY DIGITAL +
DOLBY TrueHD (*4)	DOLBY TrueHD
	DOLBY HD+EX
	DOLBY HD+PLIIx CINEMA
	DOLBY HD+PLIIx MUSIC
DTS (5.1ch) / DTS-ES Discrete 6.1 / DTS-ES Matrix 6.1 / DTS 96/24	DTS SURROUND
	DTS+PLIIx CINEMA
	DTS+PLIIx MUSIC
	DTS+NEO:6
	DTS ES MTRX6.1 (*1)
	DTS ES DSCRT6.1 (*2)
	DTS 96/24 (*3)
DTS-HD (*4)	DTS-HD HI RES
	DTS-HD MSTR
	DTS-HD+NEO:6
	DTS-HD+PLIIx CINEMA
	DTS-HD+PLIIx MUSIC
PCM (multi ch)	MULTI CH IN
	MULTI IN+PLIIx CINEMA
	MULTI IN+PLIIx MUSIC
	MULTI CH IN 7.1

- \*1 : This is displayed when the input signal is “DTS-ES Matrix 6.1” and the AVR-1909’s “AFDM” setting is set to “ON”.
- \*2 : This is displayed when the input signal is “DTS-ES Discrete 6.1”.
- \*3 : This is displayed when the input signal is “DTS 96/24”.
- \*4 : When a signal is input, the HD AUDIO indicator lights.



For details, see pages 78, 79.

## ② DSP Simulation Playback

The desired mode according to the program source and viewing situation can be selected from among 7 **DENON original surround modes**.

The surround parameters can be adjusted (🔧 page 76, 77) to achieve an even more realistic, powerful sound field.

### Selecting the surround mode

Select by turning <SELECT/ENTER> or pressing [SIMU].

#### [Selectable items]

- 5CH / 7CH STEREO** \*1 : This mode is for enjoying stereo sound from all speakers.
- ROCK ARENA** : This mode is for enjoying the atmosphere of a live concert in an arena.
- JAZZ CLUB** : This mode is for enjoying the atmosphere of a live concert in a jazz club.
- MONO MOVIE** \*2 : This mode is for playing monaural movie sources with surround sound.
- VIDEO GAME** : This mode is suited for achieving surround sound with video games.
- MATRIX** : This mode lets you add a sense of expansion to stereo music sources.
- VIRTUAL** : This mode is for enjoying surround effects using only the front speakers or headphones.

\*1: “5CH STEREO” is displayed when “Surround Parameter” – “SB CH Out” is “OFF”, and “Amp Assign” is set to “ZONE2” (🔧 page 35, 48).

\*2: When playing sources recorded in monaural in the MONO MOVIE mode, the sound will be off balance with a single channel (left or right), so input to both channels.



Depending on the program source being played, it may not be possible to achieve a satisfactory surround effect. In this case, try other modes to achieve a sound field suited to your tastes.

#### NOTE

When the input signal is DOLBY TrueHD, DOLBY DIGITAL Plus, DTS-HD you cannot select DENON original surround mode.

## ③ Direct Playback

### Selecting the mode

Select by turning <SELECT/ENTER> or pressing [D/ST].

#### [Selectable items]

#### DIRECT :

In this mode the signals bypass the tone adjustment circuitry for high quality sound.

The sound is output to the same channels as the input signal.

Input signal	Display
Analog signal / PCM (2ch) / Dolby Digital source / DTS source / Other 2-channel digital signals	DIRECT
PCM (multi ch)	MULTI CH DIRECT
	M DIRECT + PLIIx CINEMA
	M DIRECT + PLIIx MUSIC
	M DIRECT 7.1



For details, see page 79.

## ④ Stereo Playback

### Selecting the mode

Select by turning <SELECT/ENTER> or pressing [D/ST].

#### [Selectable items]

#### STEREO :

This is the mode for playing in stereo. The tone can be adjusted. Sound is output from the front left and right speakers and subwoofer.

### Operating from the main unit

Use **<SELECT/ENTER>** to select the surround mode.

#### □ During PCM (2ch) / Analog / DOLBY DIGITAL (2ch)



\* : It is possible to play analog input signals and PCM (2-channel, 48 kHz or less) in the surround mode.

#### □ During Digital (Multi channel)



### Playback in the PURE DIRECT Mode

This is the mode that recreates the original sound most faithfully, providing extremely high quality sound.

Press **[PURE]**.



- To cancel, press **[PURE]** again.
- When in the PURE DIRECT mode, the on-screen display is not displayed and the display on the main unit is turned off.
- If the HDMI input connector is selected, video outputs are output in the PURE DIRECT mode.
- The channel level and surround parameters in the PURE DIRECT mode are the same as in the DIRECT mode.

## Parameter



### Symbols used to indicate buttons in this manual

- Button located on both the main unit and the remote control unit → **BUTTON**
- Button only on the main unit → **<BUTTON>**
- Button only on the remote control unit → **[BUTTON]**

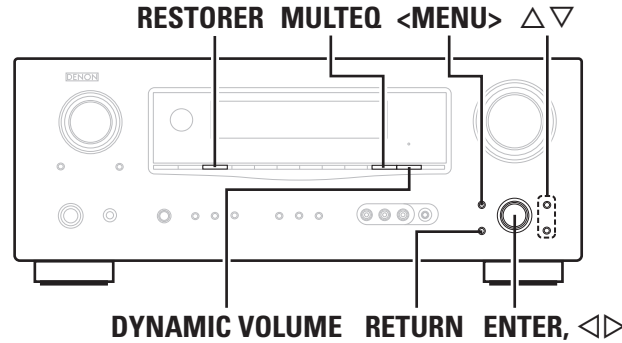

[Front]

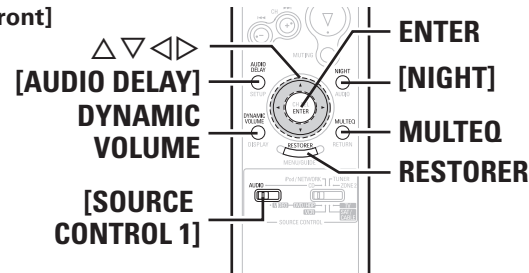

[Rear]

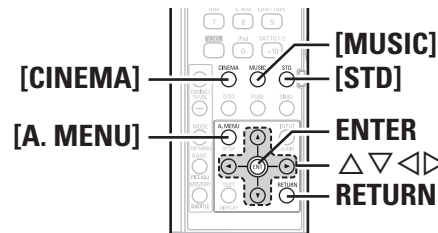

## Adjusting the parameters

### 1 Press **<MENU>** or **[A.MENU]**.

The menu is displayed.

※ To operate from the main remote control unit, be sure to set the **[SOURCE CONTROL 1]** to "AUDIO".

### 2 Use **△▽** to select "Parameter", then press **ENTER**.

### 3 To change the setting:

Press **△▽** to select the item you want to change, then press **◀▶** to change the setting.

※ To return to the previous item, press **RETURN**.

※ Select "Default Yes", then press **◀** to reset to the default setting.

### 4 Press **ENTER** to enter the setting.

#### □ To exit adjustment

Press **<MENU>** or **[A.MENU]** during adjustment.

## Surround Parameter

Adjust surround sound parameters.

The parameters (items) which can be adjusted differ depending upon the following conditions.

- Whether an input signal is present (when playing) or not (when stopped, etc.).
- The type of input signal
- The type of surround mode

For details of which parameters can be adjusted in each surround mode, see "Surround Modes and Parameters" (📖 page 76, 77).

### Surround Parameter

- 1 Mode
- 2 Cinema EQ
- 3 DRC
- 4 Dynamic Range Compression
- 5 LFE
- 6 Center Image
- 7 Panorama
- 8 Dimension
- 9 Center Width
- 10 Delay Time
- 11 Effect Level
- 12 Room Size
- 13 AFDM
- 14 SB CH Out
- 15 SW ATT (SUBWOOFER ATT)
- 16 Subwoofer
- 17 Default

### Tone

- 18 Tone Control
- 19 Bass
- 20 Treble

### Audyssey Settings

- 21 MultEQ
- 22 Dynamic EQ
- 23 Dynamic Volume
- 24 Setting

### RESTORER

### Night Mode

### Audio Delay

### Menu screen

4. Parameter
- 1. Surround Parameter
  - 2. Tone
  - 3. Audyssey Settings
  - 4. RESTORER
  - 5. Night Mode
  - 6. Audio Delay

## Surround Parameter

Adjust surround sound parameters.

The adjustable parameters differ for the different surround modes (📖 page 76, 77).

### 1 Mode

Select the mode to match the source (cinema source, music source, etc.).

#### In the PLIIx or PLII mode

[Selectable items]

**Cinema** : This is the mode for cinema source.

**Music** : This is the mode for music source.

**Game** : This is the mode for game source.

**PL** : Dolby Pro Logic playback mode (PLII mode only).  
(This is the mode for 4-channel playback (front L, front R, center, surround (MONO)).)

#### In the DTS NEO:6 mode

[Selectable items]

**Cinema** : This is the mode for cinema source.

**Music** : This is the mode for music source.



### Operating from the main remote control unit

"Cinema" mode and "Music" mode crossover operation is executed with the main remote control unit.

Press **[CINEMA]** or **[MUSIC]**.



The "Music" mode is also effective for movie sources including a lot of stereo music.

### 2 Cinema EQ

Soften the treble range of movie soundtracks for better understanding.

[Selectable items]

**ON** : "Cinema EQ" is used.

**OFF** : "Cinema EQ" is not used.

### 3 DRC

Compress dynamic range (difference between loud and soft sounds).

[Selectable items] **Auto** **Low** **Middle** **High** **OFF**



This can be set in the Dolby TrueHD mode.

### 4 Dynamic Range Compression

Compress dynamic range (difference between loud and soft sounds).

[Selectable items]

**OFF** : Turn dynamic range compression off.

**Low** : Low setting.

**Mid** : Middle setting.

**High** : High setting.



When playing DTS sources, this is only displayed for compatible software.

### 5 LFE

Adjust the low-frequency effects level (LFE).

[Variable range] **-10dB** ~ **0dB**



For proper playback of the different program sources, we recommend setting to the values below.

- Dolby Digital sources: "0 dB"
- DTS movie sources: "0 dB"
- DTS music sources: "-10 dB"



## 6 Center Image

Assign center channel signal to front left and right channels for wider sound.

[Variable range] 0.0 ~ 0.3 ~ 1.0

## 7 Panorama

Assign front L/R signal also to surround channels, for wider sound. If the surround effect seems weak, set "Panorama" to "ON".

[Selectable items] ON OFF

## 8 Dimension

Shift sound image center to front or rear, to adjust playback balance.

[Variable range] 0 ~ 3 ~ 6

## 9 Center Width

Assign center channel signal to front left and right channels for wider sound.

[Variable range] 0 ~ 3 ~ 7

## 10 Delay Time

Adjust delay time to control sound stage size.

[Variable range] 0 ms ~ 30 ms ~ 110 ms

## 11 Effect Level

Adjust the strength of the surround effect.

[Variable range] 1 ~ 10 ~ 15



Set to a lower level if the positioning and sense of phase of the surround signals seems unnatural.

## 12 Room Size

Determine size of acoustic environment.

### [Selectable items]

- Small** : Simulate acoustics of a small room.
- Med.S** : Simulate acoustics of a medium-small room.
- Medium** : Simulate acoustics of a medium room.
- Med.L** : Simulate acoustics of a medium-large room.
- Large** : Simulate acoustics of a large room.

### NOTE

"Room Size" does not indicate the size of the room in which sources are played.

## 13 AFDM (Auto Flag Detect Mode)

Auto-select surround mode by source.

This function only works for software containing a special identification signal.

If the software being played is recorded in Dolby Digital EX or DTS-ES, it is played in 6.1-channels. If not, it is played in 5.1-channels.

[Selectable items] ON OFF

### Example : Playing Dolby Digital software (with EX flag)

- When "AFDM" is set to "ON", the surround mode is automatically set to the DOLBY + PLIIx CINEMA mode.
- To play in the Dolby Digital EX mode, set "AFDM" to "OFF" and "SB CH Out" to "MTRX ON".



- Some Dolby Digital EX sources do not include EX flags. If the playback mode does not switch automatically even when "AFDM" is set to "ON", set "SB CH Out" to "MTRX ON" or "PLIIx CINEMA".
- When the "Amp Assign" setting is "7.1ch", and using the surround back speakers, you can set "AFDM".

## 14 SB CH Out (for Multi-channel sources)

Select playback mode for surround back channels.

### [Selectable items]

- OFF** : No signal is played from the surround back channels.
- MTRX ON** : The surround channel signals undergo digital matrix processing and are output from the surround back channels.
- PLIIx CINEMA** \*1 : Decoded in Dolby Pro Logic IIx Cinema mode, surround back signal played.
- PLIIx MUSIC** \*2 : Decoded in Dolby Pro Logic IIx Music mode, surround back signal played.
- ES MTRX** \*3 : DTS signal played with digital matrix processing.
- ES DSCRT** \*4 : Signal included in DTS-ES Discrete 6.1-channel sources played.
- DSCRT ON** : Mode for discrete playback of surround back signals included in 7.1-channel digital discrete audio signals (DVD, etc.).

\*1: This can be selected when "Surround Back Speaker" is set to "2spkr" at the menu "Manual Setup" – "Speaker Setup" – "Speaker Configuration" setting (page 29).

\*2: This can be selected when "Surround Back Speaker" is set to "2spkr" or "1spkr" at the menu "Manual Setup" – "Speaker Setup" – "Speaker Configuration" setting.

\*3: This can be selected when playing DTS sources.

\*4: This can be selected when playing DTS sources including a discrete 6.1-channel signal identification signal.



Settings can also be made when [STD] is pressed.

When using surround back speakers, adopt the following settings.

- ① Adopt "7.1ch" for the "Amp Assign" setting.
  - The default setting for the Amp Assign mode of AVR-1909 is "ZONE2".
- ② Adopt a setting other than "OFF" for the "SB CH Out" setting of "Surround Parameter".

**14 SB CH Out** (for 2-channel sources)

Determine whether to use surround back speakers.

**[Selectable items]**

**ON** : The surround back channel signal is played.

**OFF** : The surround back channel signal is not played.

**15 SW ATT (SUBWOOFER ATT.)**

Attenuate subwoofer level when using EXT. IN mode.

**[Selectable items]**

**ON** : The input from the subwoofer channel is attenuated.

**OFF** : The input from the subwoofer channel is not attenuated.  
Usually use in this mode.



Set this to "ON" if the subwoofer channel level seems too high when playing audio signal.

**16 Subwoofer**

Turn subwoofer output on and off.

**[Selectable items]**

**ON** : The subwoofer is used.

**OFF** : The subwoofer is not used.

**17 Default**

Resets the settings to the default values.

**Tone**

Adjust the tonal quality of the sound.

**18 Tone Control**

Turn tone adjustments off.

**[Selectable items]**

**ON** : Allow tone adjustment (treble, bass).

**OFF** : Playback without tone adjustment.



The tone cannot be adjusted when in the DIRECT mode.

**NOTE**

When the "Dynamic EQ" setting is "ON", setting is not possible.

**19 Bass**

Adjust low frequency range (bass).

**[Variable range]** **-6dB ~ +6dB**

**20 Treble**

Adjust high frequency range (treble).

**[Variable range]** **-6dB ~ +6dB**



"Bass" and "Treble" can be set when "Tone Control" is set to "ON".

**Audyssey Settings**

Select room equalizer for current environment.

**21 MultEQ**

Select the type of room correction desired from the following list:

**[Selectable items]**

**Audyssey** : Optimize frequency response of all speakers.

**Audyssey Byp. L/R** : Optimize frequency response of speakers except front L and R speakers.

**Audyssey Flat** : Optimize frequency response of all speakers to flat response.

**Manual** : Apply frequency response set with "Manual EQ" (page 34).

**OFF** : Turn equalizer off.

**Operating from the main unit or main remote control unit**

Press **MULTEQ**.

- When "Audyssey", Audyssey Byp. L/R" or "Audyssey Flat" is selected, "AUDYSSEY MULTEQ" lights.
- After running Auto Setup, if the Speaker Configuration, Distance, Channel Level, and Crossover Frequency have changed without increasing the number of speakers measured, only "AUDYSSEY MULTEQ" lights.



- "Audyssey", "Audyssey Byp. L/R" and "Audyssey Flat" can be selected after the auto setup procedure has been performed.
- After performing "Auto Setup", the "MultEQ" setting automatically becomes "Audyssey".
- If the settings of speakers for which "None" has been determined at "Auto Setup" are changed, "Audyssey", "Audyssey Byp. L/R" and "Audyssey Flat" cannot be selected. Either perform Auto Setup again, or return to the setting after running Auto Setup with "Auto Setup" - "Parameter Check" - "Restore".
- MultEQ and Manual EQ set to "Not Used" with "Manual Setup" - "Audio Setup" - "EQ Preset" - "EQ Customize" (page 34) on the menu, cannot be selected.
- When using headphones, "MultEQ" is set to "OFF".

## 22 Dynamic EQ

Audyssey Dynamic EQ solves the problem of deteriorating sound quality as volume is decreased by taking into account human perception and room acoustics. Audyssey Dynamic EQ works in tandem with Audyssey MultEQ to provide well-balanced sound for every listener at any volume level.

### NOTE

- “Dynamic EQ” can only be set when auto setup has been performed.
- “Dynamic EQ” cannot be set in the following situations.
  - If “Auto Setup” fails to be completed.
  - After running Auto Setup, when the number of used speakers has increased from the number of measured speakers.
- When “MultEQ” is set to “OFF”; “Dynamic EQ” is automatically set to “OFF”.
- When you set “Dynamic EQ” to “ON”; “Tone Control” and “Night Mode” are switched “OFF”.

### [Selectable items]

**ON** : Use Dynamic EQ function.

**OFF** : Do not use Dynamic EQ function.



### Operating from the main unit or main remote control unit

Press **DYNAMIC VOLUME**.

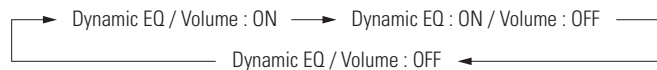

Before running Auto Setup and after running Auto Setup, if the number of speakers has increased or you pressed **DYNAMIC VOLUME**, “Run Audyssey” is displayed. In this case, either perform Auto Setup again, or return to the setting after running Auto Setup with “Auto Setup” – “Parameter Check” – “Restore”.

### Operating conditions for each function

- **Dynamic EQ** : When “MultEQ” is set to “ON”
- **Dynamic Volume** : When “Dynamic EQ” is set to “ON”
- **Setting** : When “Dynamic Volume” is set to “ON”

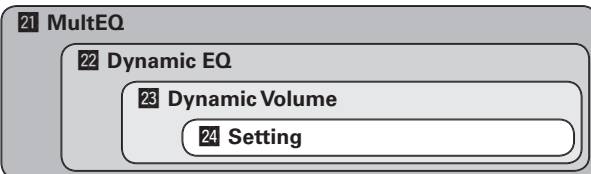

## 23 Dynamic Volume

Audyssey Dynamic Volume solves the problem of large variations in volume level between television programs, commercials, and between the soft and loud passages of movies.

Audyssey Dynamic EQ is integrated into Dynamic Volume so that as the playback volume is adjusted automatically, the perceived bass response, tonal balance, surround impression, and dialog clarity remain the same.

### NOTE

- “Dynamic Volume” can only be set when auto setup has been performed.
- “Dynamic Volume” cannot be set in the following situations.
  - If “Auto Setup” fails to be completed.
  - After running Auto Setup, when the number of used speakers has increased from the number of measured speakers.
- When “MultEQ” is set to “OFF”; “Dynamic Volume” is automatically set to “OFF”.
- “Dynamic Volume” and “Night Mode” cannot be used jointly.

### [Selectable items]

**ON** : Use Dynamic Volume.  
The Dynamic Volume effect will be at the level of the “Setting”.

**OFF** : Do not use Dynamic Volume.



### Operating from the main unit or main remote control unit

Press **DYNAMIC VOLUME**.

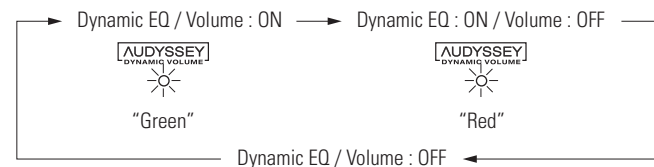

Before running Auto Setup and after running Auto Setup, if the number of speakers has increased or you pressed **DYNAMIC VOLUME**, “Run Audyssey” is displayed. In this case, either perform Auto Setup again, or return to the setting after running Auto Setup with “Auto Setup” – “Parameter Check” – “Restore”.

## 24 Setting (Dynamic Volume Setting)

Can be set when “Dynamic Volume” is set to “ON”.  
Set Dynamic Volume effect.

### [Selectable items]

**Midnight** : High setting affects volume the most, causing all sounds to be of equal loudness.

**Evening** : Middle setting prevents loud and soft sounds from being much louder and softer respectively than average sounds.

**Day** : Low setting provides the least adjustments to the loudest and softest of sounds.

### NOTE

- “Setting” can only be set when auto setup has been performed.
- “Setting” cannot be set in the following situations.
  - If “Auto Setup” fails to be completed.
  - After running Auto Setup, when the number of used speakers has increased from the number of measured speakers.
  - If “Dynamic Volume” setting is “OFF”.

### About Dynamic EQ

Audyssey Dynamic EQ™ solves the problem of deteriorating sound quality as volume is decreased by taking into account human perception and room acoustics. Dynamic EQ selects the correct frequency response and surround levels moment-by-moment at any user-selected volume setting. The result is bass response, tonal balance, and surround impression that remain constant despite changes in volume. Dynamic EQ combines information from incoming source levels with actual output sound levels in the room, a prerequisite for delivering a loudness correction solution. Audyssey Dynamic EQ works in tandem with Audyssey MultEQ to provide well-balanced sound for every listener at any volume level.

### About Dynamic Volume

Audyssey Dynamic Volume™ solves the problem of large variations in volume level between television programs, commercials, and between the soft and loud passages of movies. Dynamic Volume looks at the preferred volume setting by the user and then monitors how the volume of program material is being perceived by listeners in real time to decide whether an adjustment is needed. Whenever necessary, Dynamic Volume makes the necessary rapid or gradual adjustments to maintain the desired playback volume level while optimizing the dynamic range. Audyssey Dynamic EQ is integrated into Dynamic Volume so that as the playback volume is adjusted automatically, the perceived bass response, tonal balance, surround impression, and dialog clarity remain the same whether watching movies, flipping between television channels, or changing from stereo to surround sound content.

## RESTORER

This function restores compressed audio signals to how they were before compression and corrects the sense of volume of the bass and treble to obtain richer playback sound.

### [Selectable items]

**OFF** :

Do not use RESTORER.

**Mode1** (RESTORER 64):

Optimized mode for compressed sources with very weak highs.

**Mode2** (RESTORER 96):

Apply suitable bass and treble boost for all compressed sources.

**Mode3** (RESTORER HQ):

Optimized mode for compressed sources with normal highs.

The default setting for "iPod" is "Mode3". All others are set to "OFF".

When set to something other than "OFF", "**RESTORER**" is displayed.

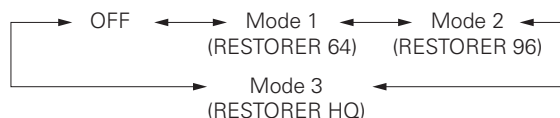

### Operating from the main unit or main remote control unit

Press **RESTORER**.

#### About the RESTORER function

- Such compressed audio formats as MP3, WMA (Windows Media Audio) and MPEG-4 AAC reduce the amount of data by eliminating signal components that are hard for the human ear to hear. The RESTORER function generates the signals eliminated upon compression, restoring the sound to conditions near those of the original sound before compression. It also corrects the sense of volume of the bass to obtain richer sound with compressed audio signals.
- This is displayed on the menu and can be set when the input source is selected to "XM", or analog signals (including AM/FM and SIRIUS signals) or PCM signals (fs = 44.1/48 kHz) are input.

## Night Mode

Optimized setting for late-night listening.

Set the dynamic range compression of the output audio.

### [Selectable items]

**OFF** : Turn night mode off.

**Low** : Low setting.

**Mid** : Middle setting.

**High** : High setting.



### Operating from the main remote control unit

Press **[NIGHT]**.

The "**NIGHT**" indicator lights when "Low", "Mid" or "High" is selected.



### NOTE

- When the "Dynamic EQ" setting is "ON", setting is not possible.
- When the "Dynamic Volume" setting is "ON", setting is not possible.
- When a HD-Audio (DOLBY DIGITAL Plus, DOLBY TrueHD, DTS-HD) signal is input, the "Night Mode" can not be selected.

## Audio Delay

Compensate for mismatched timing between video and audio.

Delay audio.

This sets the delay time for audio signals.

[Variable range] **0 ms** ~ **200 ms**

If you wish to adjust the "Audio Delay" while playing HDMI or component video signals, press  $\Delta$  to set "OSD" to "OFF". This way the audio delay can be adjusted while watching the picture. (Press  $\Delta$  again to switch to the on-screen display.)



### Operating from the main remote control unit

Press **[AUDIO DELAY]**.

### NOTE

- When operating by remote control, the onscreen display is not shown.
- This cannot be adjusted when playing in the EXT. IN, DIRECT or STEREO mode (with "Front Speaker" set to "Large", "Tone Control" to "OFF" and "MultEQ", "RESTORER" and "Night Mode" to "OFF".)
- When the auto lip sync correction function is operating, you can set within the range 0 ~ 100 ms.
- Store "Audio Delay" for each input source.

# Information

**Symbols used to indicate buttons in this manual**

- Button located on both the main unit and the remote control unit → **BUTTON**
- Button only on the main unit → **<BUTTON>**
- Button only on the remote control unit → **[BUTTON]**

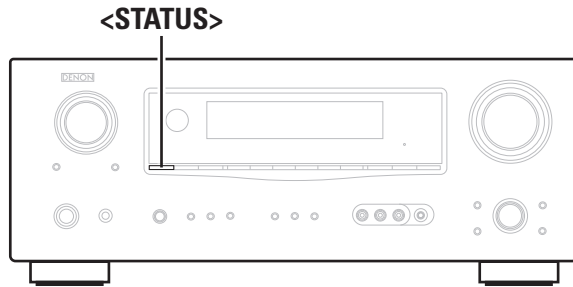

Information can be called out directly by pressing **<STATUS>**.

## Status

Shows information about current settings.

### ● Menu screen ●

```

5. Information
┌─┐ 1. Status
  2. Audio Input Signal
  3. HDMI Information
  4. Auto Surround Mode
  5. Quick Select
  6. Preset Station

5-1. Status
Select Source: DVD
Name           : Rename

Surround Mode:
DOLBY PLIIX cinema

Input Mode   : Analog
    
```

### 1 MAIN ZONE

Shows information about settings for MAIN ZONE.  
The items displayed differ according to the input source.

#### [Items to be checked]

- Select Source   Name   Surround Mode   Input Mode
- Rec Select   Video Select   Source Level   MultEQ
- Dynamic EQ   Dynamic Volume   Night Mode   RESTORER etc.

### 2 ZONE2

Shows information about settings for multi-zone.

#### [Items to be checked]

- Power   Select Source   Volume Level

## Audio Input Signal

Shows information about audio input signals.

### ● Menu screen ●

```

5. Information
┌─┐ 1. Status
  2. Audio Input Signal
  3. HDMI Information
  4. Auto Surround Mode
  5. Quick Select
  6. Preset Station

5-2. Audio Input Signal
Surround Mode:
DOLBY DIGITAL EX

SIGNAL: Dolby Digital
fs       : 48kHz
Format  : 3/2/.1
Offset  : -4dB
    
```

#### [Items to be checked]

**Surround Mode** : The currently set surround mode is displayed.

**SIGNAL** : The input signal type is displayed.

**fs** : The input signal's sampling frequency is displayed.

**Format** : The number of channels in the input signal (front, surround, LFE) is displayed.

**Offset** : The dialogue normalization correction value is displayed.

**Flag** : "MATRIX" is displayed if the input signal has undergone matrix processing, "DISCRETE" if the input signal has undergone discrete processing.

### Dialogue normalization function

This is automatically activated when playing Dolby Digital sources. This function automatically corrects the standard signal level for individual program sources. The correction value can be checked using **<STATUS>**.

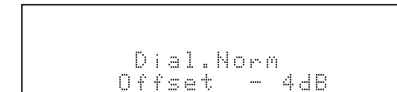

The figure is the correction value when the standard level is corrected.

## HDMI Information

Shows information about HDMI input signals and monitor.

### ● Menu screen ●

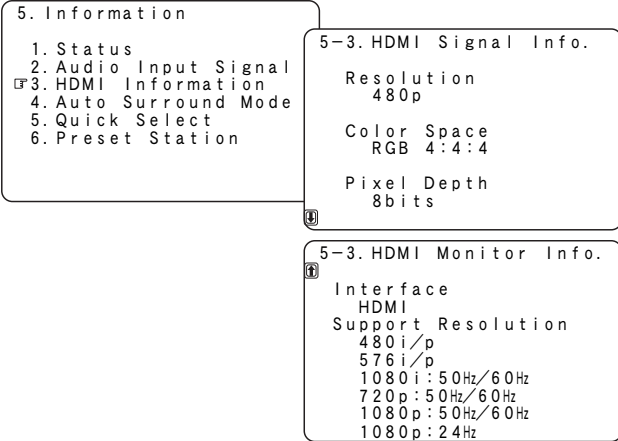

### 1 HDMI Signal Information

The HDMI input signal information is displayed.

#### [Items to be checked]

**Resolution** **Color Space** **Pixel Depth**

### 2 HDMI Monitor Information

The HDMI monitor information is displayed.

#### [Items to be checked]

**Interface** **Support Resolution**

## Auto Surround Mode

Shows information about auto surround mode settings. The surround mode for which the last memory function was used for the different input signal types is displayed.

### ● Menu screen ●

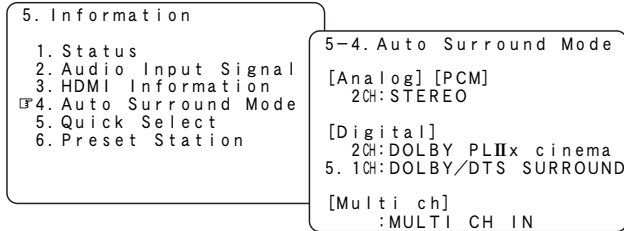

#### [Items to be checked]

**Analog/PCM 2CH** **Digital 2CH** **Digital 5.1CH** **Multi ch**

## Quick Select

Shows information about quick select settings.

### ● Menu screen ●

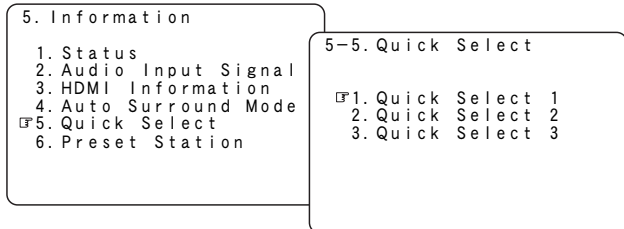

#### [Items to be checked]

**Name** **Input Source** **Input Mode** **Volume Level** **MultEQ**  
**Dynamic EQ** **Dynamic Volume** **Front Sp** **Digital 2CH**  
**Digital 5.1CH** **Multi ch** **Analog/PCM 2CH**



For instructions on storing settings at Quick Select 1 to 3, see page 64.

## Preset Station

Shows information about preset stations.

### ● Menu screen ●

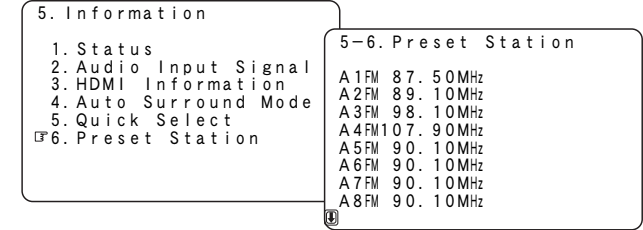

#### [Input source]

**TUNER** **XM** **SIRIUS**

#### [Items to be checked] **A1 ~ G8**



When **<STATUS>** is pressed, the set's status can be checked on the display.



# Playback

**Symbols used to indicate buttons in this manual**

- Button located on both the main unit and the remote control unit → **BUTTON**
- Button only on the main unit → **<BUTTON>**
- Button only on the remote control unit → **[BUTTON]**

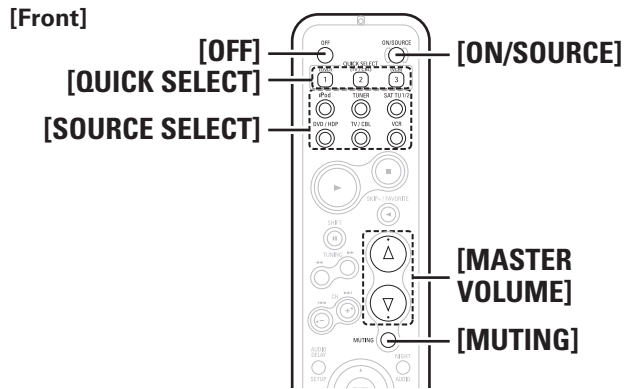
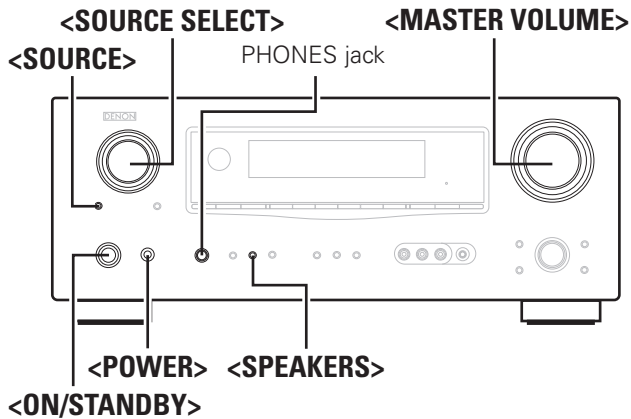

## Preparations

### Turning the Power On

- 1 Press <POWER>.**  
The power indicator lights red and the power is set to the standby mode.
- 2 Press <ON/STANDBY> or [ON/SOURCE].**  
The power indicator flashes green and the power turns on.  
  - ※ Also press **SOURCE SELECT** when in standby mode, the power turns on. In this case the input source is selected by remote control unit.
  - ※ Also press **[QUICK SELECT]** when in standby mode, the power turns on. In this case Quick Select is selected.

### Turning the Power Off

- 1 Press <ON/STANDBY> or [OFF].**  
The power is set to the standby mode.
- 2 Press <POWER>.**  
The power indicator turns off, and so does the power.

**NOTE**

- Power continues to be supplied to some of the circuitry even when the power is in the standby mode. When leaving home for long periods of time or when traveling, either press **<POWER>** to turn off the power, or unplug the power cord from the power outlet.
- When the multi-zone power is switched on, and you want to switch off the main zone power, press **[OFF]**.

### Selecting the Input Source

**Select the source using SOURCE SELECT.**  
Turn **<SOURCE SELECT>** or press **[SOURCE SELECT]** to switch between input sources.



If "Rec Select" is selected for the input source, press **<SOURCE>** before turning **<SOURCE SELECT>**.

## Operations During Playback

### Adjusting the Master Volume

Either turn **<MASTER VOLUME>** or press **[MASTER VOLUME]**.

[Variable range] --- -80.0dB ~ +18.0dB

**NOTE**

The adjustable range will differ depending upon factors such as the type of input signal and the channel level setting.

### Turning Off the Sound Temporarily (Muting)

Press **[MUTING]**.



To cancel, press **[MUTING]** again. Muting can also be canceled by adjusting the master volume.

### Listening with Headphones

**Plug the headphones into the PHONES jack on the main unit.**

The sound from the speakers and pre-out connectors is automatically cut.

**NOTE**

Be careful not to set the volume too high when using headphones.

### Switching the front speakers

Press **<SPEAKERS>**.





**Symbols used to indicate buttons in this manual**

Button located on both the main unit and the remote control unit → **BUTTON**  
 Button only on the main unit → **<BUTTON>**  
 Button only on the remote control unit → **[BUTTON]**

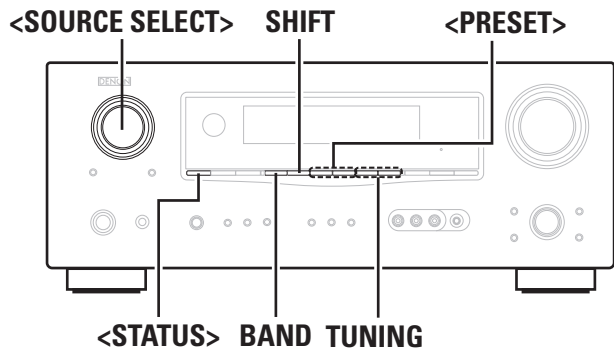

[Front]

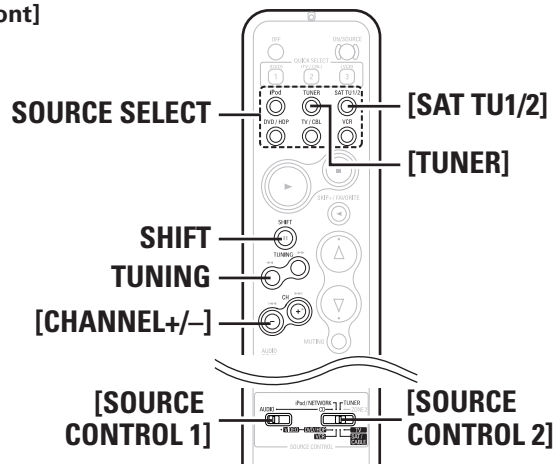

[Rear]

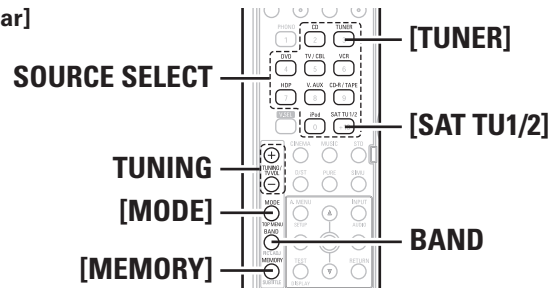

## Playing Video and Audio Equipment

### Basic Operation

#### 1 Prepare the equipment.

- ① Load the BD, DVD, CD or other software in the player.  
(☞ See the operating instructions of the respective equipment.)
- ② To play a video equipment, switch the monitor input.  
(☞ See the monitor's operating instructions.)

#### 2 Use SOURCE SELECT to select the input source.

#### 3 Start playback.

(☞ See the operating instructions of the respective equipment.)



The remote control unit can be used to operate external devices.  
See "Remote Control Unit Operations" (☞ page 65).

## Listening to FM/AM Broadcasts

### Basic Operation

#### 1 Either turn <SOURCE SELECT> or press [TUNER] to select "TUNER".

#### 2 Set [SOURCE CONTROL 1] to "AUDIO" and [SOURCE CONTROL 2] to "TUNER".

(☞ page 65 "Remote Control Unit Operations")

#### 3 Press BAND to select "FM" or "AM".

#### 4 Tune in the desired broadcast station.

##### ① To tune in automatically (Auto Tuning)

Press **[MODE]** to light the "AUTO" indicator on the display, then use **TUNING** to select the station you want to hear.

##### ② To tune in manually (Manual Tuning)

Press **[MODE]** to turn off the display's "AUTO" indicator, then use **TUNING** to select the station you want to hear.



- If the desired station cannot be tuned in with auto tuning, tune it in manually.
- When tuning in stations manually, press and hold **TUNING** to change frequencies continuously.
- The time for which the on-screen display are displayed can be set at "Manual Setup" – "Option Setup" – "On-Screen Display" (☞ page 36).

### Presetting Radio Stations (Preset Memory)

Your favorite broadcast stations can be preset so that you can tune them in easily. Up to 56 stations can be preset.

#### 1 Tune in the broadcast station you want to preset.

#### 2 Press [MEMORY].

#### 3 Press SHIFT to select the block (A to G) in which the station is to be preset.

#### 4 Press <PRESET> or [CHANNEL +/-] to select the preset number (1 to 8).

#### 5 Press [MEMORY] again to complete the setting.



- To preset other stations, repeat steps 1 to 5.
- Stations can be preset automatically at menu "Input Setup" – "Auto Preset" (☞ page 39).

#### NOTE

Preset stations are erased by overwriting them.

## Listening to Preset Stations

- 1** Press **SHIFT** to select the memory block (A to G).
- 2** Press **<PRESET>** or **[CHANNEL +/-]** to select the desired preset channel (1 to 8).

### Default settings

Auto tuner presets	
A1 ~ A8	87.5 / 89.1 / 98.1 / 107.9 / 90.1 / 90.1 / 90.1 / 90.1 MHz
B1 ~ B8	520 / 600 / 1000 / 1400 / 1500 / 1710 kHz, 90.1 / 90.1 MHz
C1 ~ C8	90.1 MHz
D1 ~ D8	90.1 MHz
E1 ~ E8	90.1 MHz
F1 ~ F8	90.1 MHz
G1 ~ G8	90.1 MHz

## Listening to XM Satellite Radio Programs

### About XM Radio

XM is North America's number one satellite radio company, offering an extraordinary variety of commercial-free music, plus the best in premier sports, news, talk radio, comedy, children's and entertainment programming, broadcast in superior digital audio quality coast to coast. For more information, or to subscribe, U.S. customers visit [xmradio.com](http://xmradio.com) or call XM Listener Care at 1-800- XMRADIO (1-800-967-2346); Canadian customers visit [xmradio.ca](http://xmradio.ca) or call XM Listener Care at 1-877-GETXMSR (1-877-438-9677).

### XM Ready® Legal

XM monthly service subscription sold separately. XM Mini-Tuner and Home Dock required (each sold separately) to receive XM service. It is prohibited to copy, decompile, disassemble, reverse engineer, hack, manipulate or otherwise make available any technology or software incorporated in receivers compatible with the XM satellite Radio System. Installation costs and other fees and taxes, including a one-time activation fee may apply. All fees and programming subject to change. Channels with frequent explicit language are indicated with an XL. Channel blocking is available for XM radio receivers by calling 1-800-XMRADIO (U.S. residents) and 1-877-GETXMSR (Canadian residents). XM Service only available in the 48 contiguous United States and Canada. ©2008 XM Satellite Radio Inc. All rights reserved.

## XM Ready® Subscription

Once you have installed the XM Mini-Tuner Home Dock, inserted the XM Mini-Tuner, connected the XM Mini-Tuner Home Dock to your XM Ready® audio system, and installed the antenna, you are ready to subscribe and begin receiving XM programming. There are three places to find your eight character XM Radio ID: On the XM Mini-Tuner, on the XM Mini-Tuner package, and on XM Channel 0. Record the Radio ID below for reference.



**Note:** The XM Radio ID does not use the letters "I", "O", "S" or "F". Activate your XM Satellite Radio service in the U.S. online at <http://activate.xmradio.com> or call 1-800-XMRADIO (1-800-967-2346). Activate your XM Satellite Radio service in Canada online at <https://activate.xmradio.ca> or call 1-877-GET-XMSR (1-877-438-9677). You will need a major credit card. XM will send a signal from the satellites to activate the full channel lineup. Activation normally takes 10-15 minutes, but during peak busy periods you may need to keep your XM Ready audio system on for up to an hour. When you can access the full lineup on your XM Ready audio system you are done.

## Basic Operation

- 1** Either turn **<SOURCE SELECT>** or press **[SAT TU1/2]** to select "XM".
- 2** Set **[SOURCE CONTROL 1]** to "AUDIO" and **[SOURCE CONTROL 2]** to "TUNER".  
(☞ page 65 "Remote Control Unit Operations")
- 3** Use **TUNING** to select the station.  
When the station is tuned in, the name of the track and artist are displayed.



- The channel switches continuously when **TUNING** is pressed and held.
- The artist name, track name, category and reception level can be checked by pressing **<STATUS>**.
- The time for which the on-screen display are displayed can be set at menu "Manual Setup" – "Option Setup" – "On-Screen Display" (☞ page 36).

## Checking the XM Signal Strength and Radio ID

- 1** Either turn **<SOURCE SELECT>** or press **[SAT TU1/2]** to select "XM".
- 2** Press **<STATUS>** until "SIGNAL" appears on the display.  
The display will switch as shown below, depending on the reception conditions.
- 3** Adjust the position of the antenna until "SIGNAL: GOOD" is shown on the display.
- 4** Press **<STATUS>** until the station you want to check (example: "XM001") is displayed.
- 5** Press **TUNING** and select channel 0 (XM000).  
The radio ID is shown on the display.



The strength of both the XM satellite and terrestrial signals can be checked at menu "Input Setup" – "Antenna Aiming" (☞ page 43).

Display	Status
<b>GOOD</b>	Signal strength is good
<b>MARGINAL</b>	Signal strength is marginal
<b>WEAK</b>	Signal strength is weak
<b>NO</b>	No signal

**Symbols used to indicate buttons in this manual**

Button located on both the main unit and the remote control unit → **BUTTON**  
 Button only on the main unit → **<BUTTON>**  
 Button only on the remote control unit → **[BUTTON]**

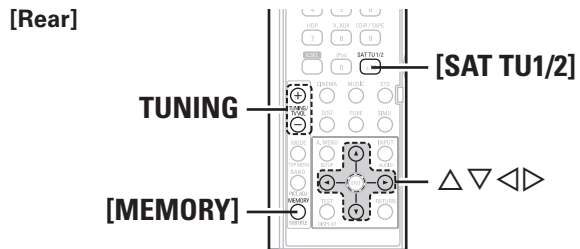
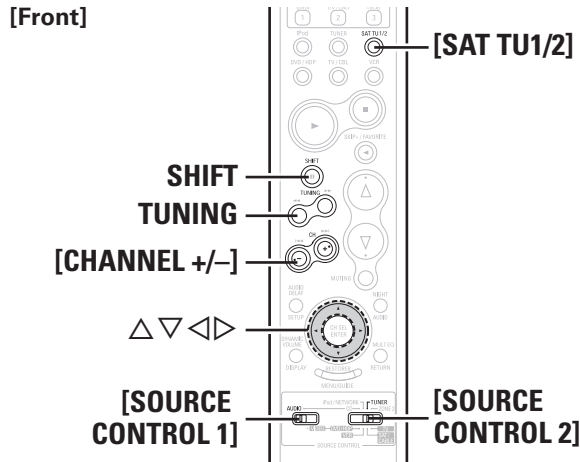
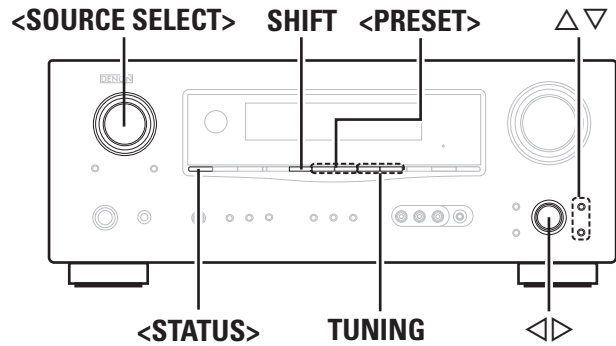

### Presetting Radio Stations (Preset Memory)

Your favorite broadcast stations can be preset so that you can tune them in easily. Up to 56 stations can be preset.

- 1** Tune in the broadcast station you want to preset.
- 2** Press **[MEMORY]**.
- 3** Press **SHIFT** to select the block (A to G) in which the station is to be preset.
- 4** Press **<PRESET>** or **[CHANNEL +/-]** to select the preset number (1 to 8).
- 5** Press **[MEMORY]** again to complete the setting.

To preset other stations, repeat steps 1 to 5.

**NOTE**  
 Preset stations are erased by overwriting them.

### Listening to Preset Stations

- 1** Press **SHIFT** to select the memory block (A to G).
- 2** Press **<PRESET>** or **[CHANNEL +/-]** to select the desired preset channel (1 to 8).

### Searching Categories

- 1** Press **<D>**.



- 2** Use **<D>** to select the category, then use **<U>** **<D>** to select the desired station.

- "LOADING" is displayed while stations or data are being received.
- Refer to "Troubleshooting" – "XM Satellite Radio" regarding other messages (page 85).

### Listening to SIRIUS Satellite Radio Programs

#### What is SIRIUS Satellite Radio?

Simply The Best Radio on Radio™ with all your favorite entertainment including 100% commercial-free music, plus superior sports coverage, uncensored talk and comedy, world-class entertainment, news, weather and more for your car, home or office. For more information visit [sirius.com](http://sirius.com) or [siriuscanada.ca](http://siriuscanada.ca)

Sirius is available in the US for subscribers with addresses in the continental US and is available in Canada for subscribers with a Canadian address. Required subscription plus compatible SIRIUS tuner and antenna are required and sold separately. SIRIUS Programming is subject to change. Visit [sirius.com](http://sirius.com) for the most complete and up-to-date channel lineup and product information. "SIRIUS" and the SIRIUS dog logo and related marks are trademarks of Sirius Satellite Radio Inc. All rights reserved.

### Basic Operation

- 1** Either turn **<SOURCE SELECT>** or press **[SAT TU1/2]** to select “SIRIUS”.
- 2** Set **[SOURCE CONTROL 1]** to “AUDIO” and **[SOURCE CONTROL 2]** to “TUNER”.  
(☞ page 65 “Remote Control Unit Operations”)
- 3** Use **TUNING** to select the station.  
When the station is tuned in, the name of the track and artist are displayed.



- The channel switches continuously when **TUNING** is pressed and held.
- SIRIUS Radio stations can be preset using the same procedure as for FM/AM stations (☞ page 55 “Presetting Radio Stations (Preset Memory)” and “Listening to Preset Stations”).  
※ You cannot perform “Auto Preset”.
- The track name, artist name, composer name, category and reception level can be checked by pressing **<STATUS>**.
- The time for which the on-screen display are displayed can be set at menu “Manual Setup” – “Option Setup” – “On-Screen Display” (☞ page 36).

### Checking the SIRIUS Signal Strength and Radio ID

- 1** Either turn **<SOURCE SELECT>** or press **[SAT TU1/2]** to select “SIRIUS”.
- 2** Press **<STATUS>** until “SIGNAL” appears on the display.  
The display will switch as shown below, depending on the reception conditions.

Display	Status
EXCELLENT	Signal strength is excellent
GOOD	Signal strength is good
WEAK	Signal strength is weak
NO SIGNAL	No signal

- 3** Adjust the position of the antenna until “SIGNAL: EXCELLENT” is shown on the display.
- 4** Press **<STATUS>** until the station you want to check (example: “SR001”) is displayed.
- 5** Press **TUNING** and select channel 0 (SR000).  
Channel No. and Sirius ID are alternately shown on the display.

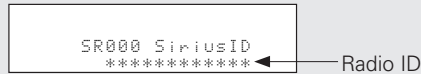

※ Write your own SIRIUS ID for storage use.

Sirius ID : \_\_\_\_\_



The strength of both the SIRIUS and terrestrial signals can be checked at menu “Input Setup” – “Antenna Aiming” (☞ page 43).

### Presetting Radio Stations (Preset Memory)

Your favorite broadcast stations can be preset so that you can tune them in easily. Up to 56 stations can be preset.

- 1** Tune in the broadcast station you want to preset.
- 2** Press **[MEMORY]**.
- 3** Press **SHIFT** to select the block (A to G) in which the station is to be preset.
- 4** Press **<PRESET>** or **[CHANNEL +/-]** to select the preset number (1 to 8).
- 5** Press **[MEMORY]** again to complete the setting.



To preset other stations, repeat steps 1 to 5.

#### NOTE

Preset stations are erased by overwriting them.

### Listening to Preset Stations

- 1** Press **SHIFT** to select the memory block (A to G).
- 2** Press **<PRESET>** or **[CHANNEL +/-]** to select the desired preset channel (1 to 8).

**Symbols used to indicate buttons in this manual**

Button located on both the main unit and the remote control unit → **BUTTON**  
 Button only on the main unit → **<BUTTON>**  
 Button only on the remote control unit → **[BUTTON]**

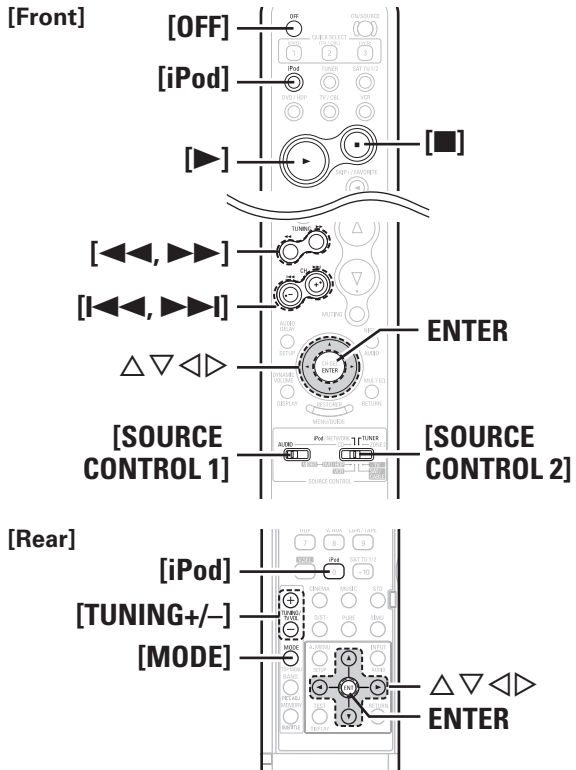
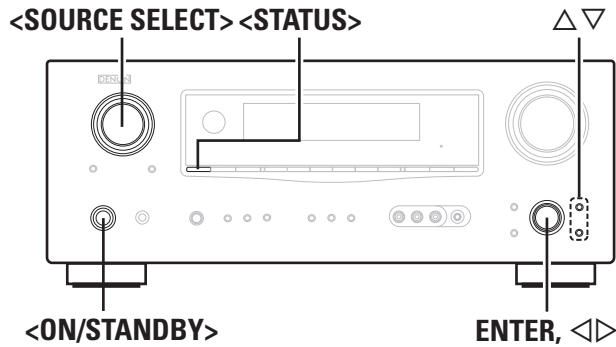

### Searching Categories

**1** Press **<Δ>** **<▽>**.

SR001 Hits 1  
CAT : Pops

← Channel category

**2** Use **<Δ>** **<▽>** to select the category, then use **Δ** **▽** to select the desired station.

- ✎ “UPDATING” is displayed while the encoding code is being updated.
- ✎ “SIRIUS UPDATING” is displayed when updating SIRIUS tuner firmware.
- ✎ Refer to “Troubleshooting” – “SIRIUS Satellite Radio” regarding other messages (☞ page 85).

### Parental Lock

**1** Tune to the channel you want to lock.

**2** Press **ENTER** for at least 3 seconds.  
“Code: [ ]” is displayed.

**3** Enter the 4-digit lock code using **Δ** **▽** **<Δ>** **<▽>**.  
When you enter the correct code, the corresponding channel is locked.

**4** Press **ENTER**.

- ✎ Channels under Parental Lock cannot be tuned in by performing Tuning Up/Down or by category search.
- ✎ Channels stored in preset memory can be tuned in by the preset channel select operation, even if Parental Lock is applied.
- ✎ When a channel to which Parental Lock is applied is being played, Parental Lock for that channel is cancelled by performing Step 2.
- ✎ See “Edit Lock Cord” (☞ page 43) for the method of changing Parental Lock Cord.
- ✎ You can also set “Parental Lock” from the menu (☞ page 43).

### iPod® Playback

The music on an iPod can be played by using the control dock for iPod (ASD-1R, ASD-3N or ASD-3W sold separately). The operation can also be performed using the buttons on the main unit or remote control unit while watching the menus.

**Made for iPod** iPod is a trademark of Apple Inc., registered in the U.S. and other countries.

※ The iPod may only be used to copy or play contents that are not copyrighted or contents for which copying or playback is legally permitted for your private use as an individual. Be sure to comply with applicable copyright legislation.

### Basic Operation

**1** Make the necessary preparations.

- ① Set the iPod in the DENON control dock for iPod.  
(☞ See the control dock for iPod’s operating instructions.)
- ② Assign the control dock for iPod’s input.  
The input for the control dock for iPod is assigned to VCR by default.

**MENU : “Input Setup” – “Assign” – “iPod dock”**  
(☞ page 42)

**2** Either turn **<SOURCE SELECT>** or press **[iPod]** to select the input source assigned in step 1-② above.

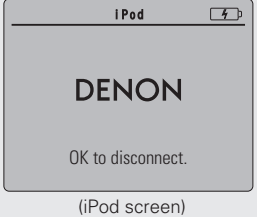

※ If the screens above are not displayed, the iPod may not be properly connected. Try connecting again.

**3** Set **[SOURCE CONTROL 1]** to “AUDIO” and **[SOURCE CONTROL 2]** to “iPod/NETWORK”.  
(☞ page 65 “Remote Control Unit Operations”)

**4** Press **[MODE]** and hold it down for a 2 seconds or more to select the display mode.

To switch between modes, press and hold down the button. When remote mode is active, "Remote" is displayed.

[Selectable mode]		Browse mode	Remote mode
Display location		Main unit display	iPod display
Playable files	Audio file	<input type="radio"/>	<input type="radio"/>
	Video file	<input type="radio"/> * 1	<input type="radio"/> * 2
Active buttons	Remote control unit (AVR-1909)	<input type="radio"/>	<input type="radio"/>
	iPod	×	<input type="radio"/>

\* 1 : When using an ASD-3N or ASD-3W control dock for iPod.  
 \* 2 : Video may not be output, depending on the combination of ASD-1R and iPod.



- With the default settings, the iPod can be used connected to the VCR (iPod) connector.
- Use the RESTORER mode to expand the low and high frequency components of compressed audio files and achieve a richer sound. The default setting is "Mode3" (page 51).
- Press **<ON/STANDBY>** or **[OFF]** and set the AVR-1909's power to the standby mode before disconnecting the iPod. Also switch the input source to one to which the menu "iPod dock" is not assigned before disconnecting the iPod.
- When using an ASD-3N or ASD-3W control dock for iPod, refer to the respective manual to operate.

**Listening to Music**

**1** Use  $\Delta$   $\nabla$  to select the menu, then press **ENTER** or  $\triangleright$  to select the music file to be played.

**2** Press **ENTER** or  $\triangleright$ . Playback starts.

**Stopping playback temporarily**

During playback, press **ENTER** or  $\triangleright$ . Press again to resume playback.

**Fast-forwarding or fast-reversing**

During playback, either press and hold  $\lll$  (to fast-reverse) or  $\ggg$  (to fast-forward).

**To cue to the beginning of a track**

During playback, either press  $\lll$  (to cue to the previous track) or  $\ggg$  (to cue to the next track).

**To stop**

During playback, either press and hold **ENTER** or press  $\blacksquare$ .

**Playing repeatedly**

Press **[TUNING -]**.

[Selectable items] **All** **One** **OFF**

MENU : "Input Setup" - "iPod" - "Repeat" (page 42)

**Shuffling playback**

Press **[TUNING +]**.

• **When DENON control dock for iPod ASD-1R is connected**

[Selectable items] **Albums** **Songs** **OFF**

MENU : "Input Setup" - "iPod" - "Shuffle" (page 43)

• **When DENON control dock for iPod ASD-3N/3W is connected**

[Selectable items] **ON** **OFF**



- To check the name of the title, the artist or the album when playing in browse mode, press **<STATUS>**.
- The folder name and the file name can be displayed in browse mode. Only alphanumeric characters and certain symbols can be displayed. Any characters that cannot be displayed are replaced with ". (period)".
- The time for which the on-screen display are displayed can be set at menu "Manual Setup" - "Option Setup" - "On-Screen Display" - "iPod Information" (page 36).

**Viewing Still Pictures or Videos on the iPod**

Photo and video data on the iPod can be viewed on the monitor. Only for iPod equipped with slideshow or video functions. (When using an ASD-1R)

**1** Press and hold **[MODE]** to set the Remote mode.

**2** Watching the iPod's screen, use  $\Delta$   $\nabla$  to select "Photos" or "Videos".

**3** Press **[ENTER]** until the image you want to view is displayed.



- "TV Out" at the iPod's "Slideshow Settings" or "Video Settings" must be set to "On" in order to display the iPod's photo data or videos on the monitor. For details, see the iPod's operating instructions.
- When viewing an iPod video file, select "iPod" - "Video" in browse mode. (When using an ASD-3N or ASD-3W)

**NOTE**

- Depending on the type of iPod and the software version, some functions may not operate.
- DENON will accept no responsibility whatsoever for any loss of iPod data.



# Other Operations and Functions



## Symbols used to indicate buttons in this manual

- Button located on both the main unit and the remote control unit → **BUTTON**
- Button only on the main unit → **<BUTTON>**
- Button only on the remote control unit → **[BUTTON]**

## <SOURCE SELECT>

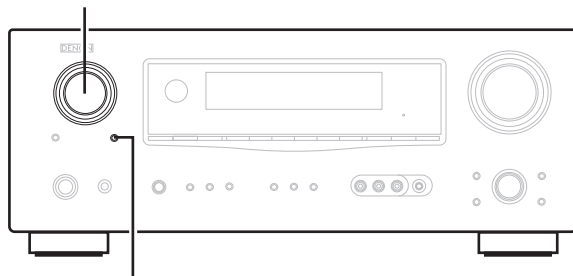

## <ZONE2/REC SELECT>

## Other Operations

### Recording on an External Equipment (REC OUT mode)

You can listen to one program source while recording a different program source.

#### 1 Press <ZONE2/REC SELECT>.

"ZONE2 SOURCE" is shown on the display.

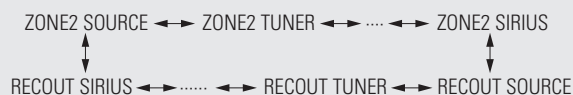

#### 2 Turn <SOURCE SELECT> until "RECOUT Source" is displayed.

The "REC" indicator lights.

#### 3 Turn <SOURCE SELECT> to choose the input source to be recorded.

#### 4 Play the program source.

For operating instructions, refer to the respective equipment's operating instructions.  
To record FM or AM broadcasts, select the broadcast (☞ page 55).

#### 5 Start recording.

For operating instructions, refer to the respective equipment's operating instructions.



- To cancel, press <ZONE2/REC SELECT>, then turn <SOURCE SELECT> until "ZONE2 Source" is displayed.
- Make a test recording before starting the actual recording.
- Sources selected with the REC OUT mode are output from ZONE2 as well.
- In the REC OUT mode, the remote control unit's ZONE2 mode buttons cannot be operated.
- The "XM" and "SIRIUS" digital audio output signals are not output from the OPTICAL2 output connector.
- The source selected for ZONE2 is output from the digital output connector (OPTICAL 2).

### NOTE

- Digital signals are not output from the analog REC OUT connector.
- Recordings you make are for your personal enjoyment and should not be used for other purposes without permission of the copyright holder.
- Input sources for which "Delete" is selected at "Source Delete" cannot be selected.



# Convenient Functions

## HDMI Control Function

When AVR-1909 is connected to a TV and player compatible with HDMI control function, you can perform the following operations. Settings other than AVR-1909 settings must be made on the respective devices. (Check the operating instructions of each device for details.)

- AVR-1909 power off can be linked to the TV power off step. When you set "Output audio from amp" in the TV audio output setup operation, you can switch the amp power on.
- You can switch audio output devices with a TV operation. (When outputting from the TV speakers, output switches from speakers connected to AVR-1909).
- You can adjust AVR-1909 volume in the TV volume adjustment operation.
- You can switch AVR-1909 functions through linkage to TV input function switching.
- When playing the player, the AVR-1909 input function switches to the function of that player.



- When you want to listen to TV audio by AVR-1909, connect optical digital or analog. If the TV you are using has both connection jacks, use the optical digital connection.
- When using these functions set as follows: menu "Manual Setup" – "HDMI Setup" – "HDMI Control" (page 32).

### NOTE

When using the HDMI control function, do not assign HDMI input to "TV/CBL" by setting "Input Setup" – "Assign" – "HDMI In" in the menu.

## Connections

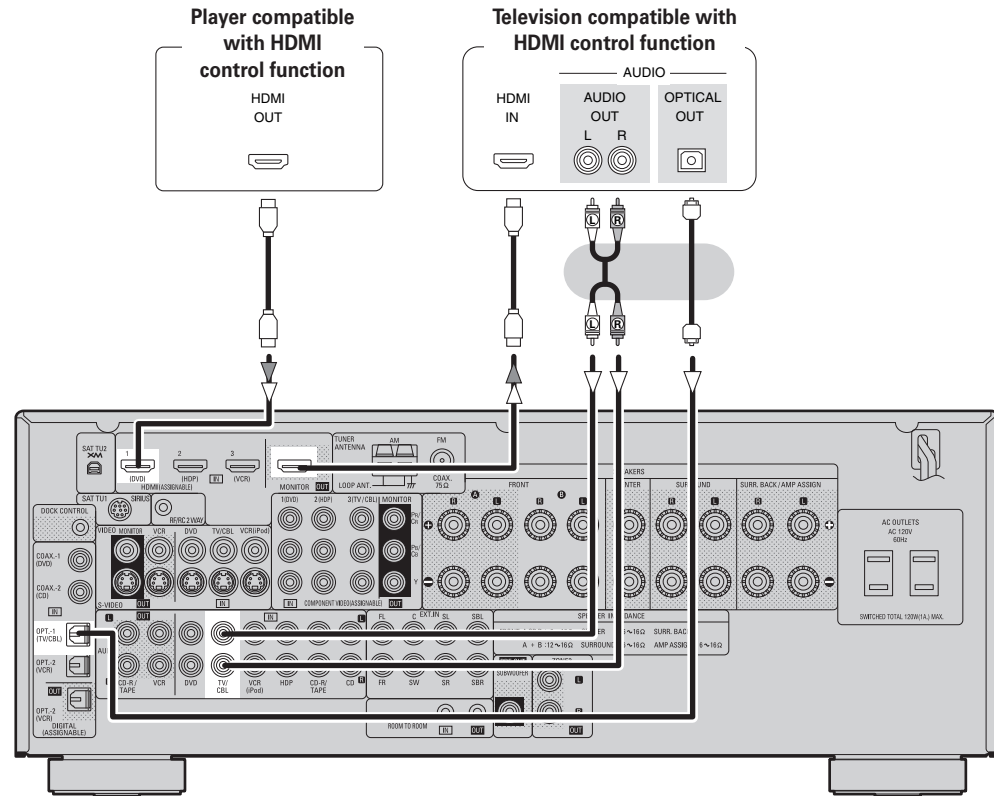

**Symbols used to indicate buttons in this manual**

Button located on both the main unit and the remote control unit → **BUTTON**  
 Button only on the main unit → **<BUTTON>**  
 Button only on the remote control unit → **[BUTTON]**

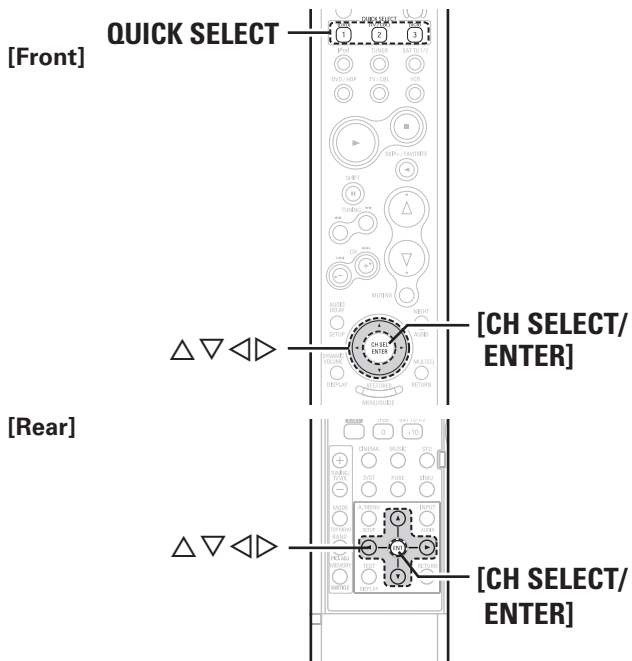
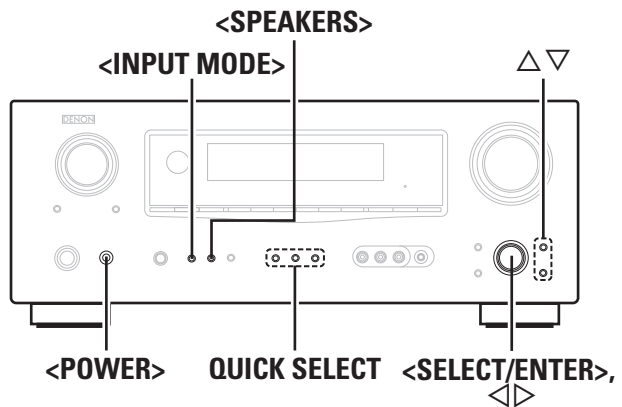

**Operations**

- 1 Connect the HDMI to the AVR-1909 with equipment compatible with the HDMI control function (page 62).**
- 2 Put the power on for all the equipment connected to the HDMI.**
- 3 Check the settings for all the equipment connected to the HDMI and make HDMI available to them.**  
 ※ Please consult the operating instructions for the connected equipment to check the settings.  
 ※ Steps 1~3 do not have to be repeated once started.  
 ※ Carryout steps 2 and 3 should any of the equipment be plugged out.
- 4 Switch the television input to the HDMI connected to the AVR-1909.**
- 5 Switch the AVR-1909 input to the HDMI input source and check if the picture from the player is ok.**
- 6 Put the television power on standby and check if the AVR-1909 goes into standby.**



- If the AVR-1909 does not work please check the following.
- Is the menu "Manual Setup" – "HDMI Setup" – "HDMI Control" (page 32) set to "ON"?
  - Is the menu "Manual Setup" – "HDMI Setup" – "Power Off Control" (page 32) set to "ON"?
  - Is the control function used for the television HDMI properly set? (Check the television operating instructions for details.)
  - Should any of the operations below be performed, the interlocking function may be reset, in which case, repeat step's 2 and 3.
    - Menu "Input Setup" – "Assign" – "HDMI In" (page 42) setting has changed.
    - There is a change to the connection between the equipment and the HDMI, or an increase in equipment.

**Channel Level**

You can adjust the channel level either according to the playback sources or to suit your taste, as described below.

- 1 Press <SELECT/ENTER> or [CH SELECT / ENTER].**

Channel Volume			
FL	◀ 0.0dB ▶	SR	0.0dB
C	0.0dB	SBR	0.0dB
FR	0.0dB	SBL	0.0dB
SW	0.0dB	SL	0.0dB
Fader			
FRONT ◀ :		▶ REAR	

- 2 Use Δ ∇, <SELECT/ENTER> or [CH SELECT / ENTER] to select the speaker.**

The speaker that can be set switches each time one of the buttons is pressed.

- 3 Use ◀ ▶ to adjust the volume.**

※ In the case of a sub woofer, reducing the volume when it is at "–12 dB" will change the setting to "OFF" (none).

**NOTE**

When the input source is "iPod", you cannot perform channel level setting.

**Fader Function**

This function lets you adjust (fade) the sound from all the front or rear speakers at once.

- 1 Press <SELECT/ENTER> or [CH SELECT / ENTER].**

- 2 Press Δ ∇, <SELECT/ENTER> or [CH SELECT / ENTER] to select "Fader".**

- 3 Use ◀ ▶ to adjust the volume of the speakers.**  
 (◀: front, ▶: rear)



- The fader function does not affect the subwoofer.
- The fader can be adjusted until the volume of the speaker adjusted to the lowest value is –12 dB.

## Quick Select Function

With this function, the currently playing input source, input mode, surround mode, MultEQ settings and volume can be stored in the memory.

**1** Set the input source, surround mode, MultEQ, Dynamic EQ, Dynamic Volume, Front Speaker settings and volume to the conditions you want to store.

**2** Press and hold the desired **QUICK SELECT** until “Memory” appears on the display.  
The current settings will be memorized.

### [Quick Select Defaults]

	Input Source	Volume
<b>Quick Select 1</b>	DVD	-40 dB
<b>Quick Select 2</b>	TV/CBL	-40 dB
<b>Quick Select 3</b>	VCR	-40 dB



- To call out the settings, press **QUICK SELECT** at which the desired settings were stored.
- The Quick Select name can be changed (🔧 page 36).

### NOTE

Input sources stored with the quick select function cannot be selected if they have been deleted at menu “Manual Setup” – “Option Setup” – “Source Delete” (🔧 page 36). In this case, store them again.

## Personal Memory Plus Function

This function sets the settings (input mode, surround mode, HDMI output mode, MultEQ, Dynamic EQ, Dynamic Volume, audio delay etc.) last selected for the individual input sources.

When you switch to an input source, the settings are automatically set to the ones that were set the last time that input source was used.



The surround parameters, tone settings and the volumes of the different speakers are stored for the individual surround modes.

## Last Function Memory

This stores the settings as they were directly before the standby mode was set.

When the power is turned back on, the settings are restored to as they were directly before the standby mode was set.

## Backup Memory

The various settings are backed up for about 1 week, even if the power is turned off or the power cord is disconnected.

## Resetting the Microprocessor

Perform this procedure if the display is abnormal or if operations cannot be performed.

When the microprocessor is reset, all the settings are reset to their default values.

**1** Turn off the power using **<POWER>**.

**2** Press **<POWER>** while simultaneously pressing **<INPUT MODE>** and **<SPEAKERS>**.

**3** Once the display starts flashing at intervals of about 1 second, release the two buttons.



If in step 3 the display does not flash at intervals of about 1 second, start over from step 1.

# Remote Control Unit Operations

## Main Remote Control Unit (RC-1099)

[Front]

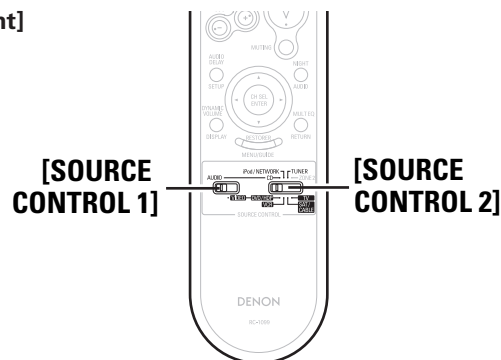

[Rear]

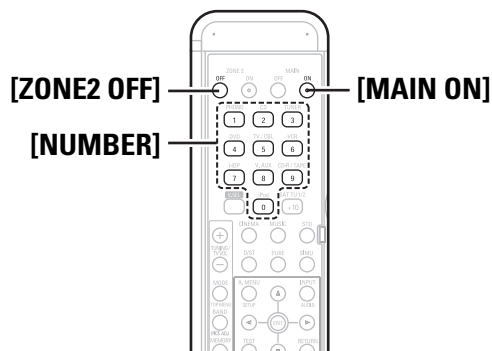

Depending on the model and year of manufacture of your equipment, some buttons may not operate.

### Operating DENON Audio Components

- 1** Set **[SOURCE CONTROL 1]** to “AUDIO”.
- 2** Set **[SOURCE CONTROL 2]** to the position for the component to be operated (CD, iPod/NETWORK or TUNER).
- 3** Operate the audio component.
  - ※ For details, refer to the component’s operating instructions.
  - ※ While this remote control is compatible with a wide range of infrared controlled components, it may be the case that some component models cannot be operated with this remote control.

### Presetting

- DENON and other makes of components can be operated by setting the preset memory.
  - Operation is not possible for some models.
- 1** Set **[SOURCE CONTROL 1]** to “AUDIO” or “VIDEO”.
    - ※ Set to the AUDIO side for the CD position, and to the VIDEO side for the DVD/HDP, VCR, SAT/CABLE or TV position.
  - 2** Set **[SOURCE CONTROL 2]** to the component to be registered.
  - 3** Press **[ZONE2 OFF]** and **[MAIN ON]** at the same time.
    - The indicator starts flashing.
  - 4** Press **[NUMBER]** and input the 3-digit number of the brand of the component to be preset. The numbers are shown in the Preset Code Table (👉 End of this manual).
  - 5** To store the codes of another component in the memory, repeat steps 1 to 4.



- The signals for the pressed buttons are emitted while setting the preset memory. To avoid accidental operation, cover the remote control unit’s transmitting window while setting the preset memory.
- Depending on the model and year of manufacture, this function cannot be used for some models, even if they are of makes listed in the list of preset codes.
- Some manufacturers use more than one type of remote control code. Refer to the included list of preset codes to change the number and verify correct operation.
- The preset memory can be set for one component only among the following: DVD/HDP and SAT/CABLE.
- VDP (Video Disc Player) can be preset when **[SOURCE CONTROL 2]** is set to “DVD/HDP”.

### Operating Preset Components

- 1** Set **[SOURCE CONTROL 1]** to “AUDIO” or “VIDEO”.
  - ※ Set to the AUDIO side for the CD position, and to the VIDEO side for the DVD/HDP, VCR, SAT/CABLE or TV position.
- 2** Set **[SOURCE CONTROL 2]** to the component you want to operate.
- 3** Operate the component.
  - ※ For details, refer to the component’s operating instructions.
  - ※ Some models cannot be operated with this remote control unit.

Functions of Buttons by Component

□ Front

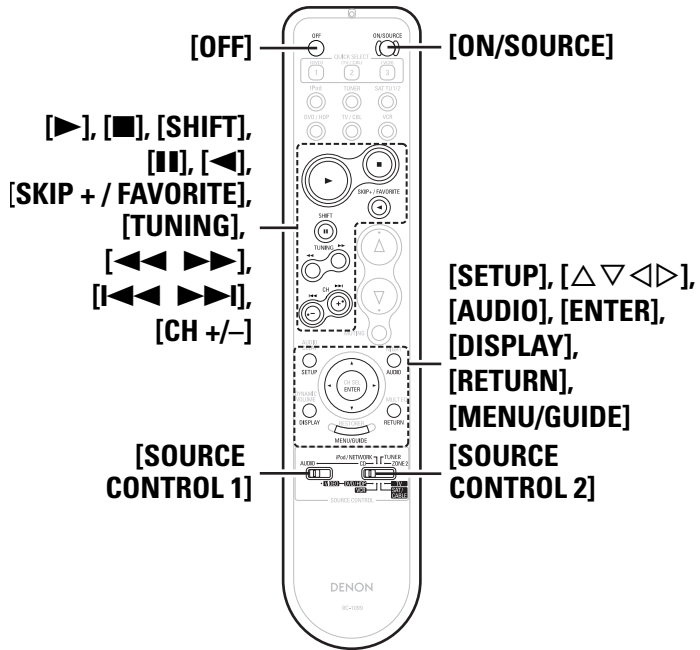

Device operated	CD Player	iPod	Tuner	DVD Player	Blu-ray Disc Player	Video Disc Player (VDP)	Video Deck	Satellite Receiver	Cable TV	TV (Monitor)
<b>SOURCE CONTROL 1</b>	<b>AUDIO</b>			<b>VIDEO</b>						
<b>SOURCE CONTROL 2</b>	<b>CD</b>	<b>iPod/ NETWORK</b>	<b>TUNER</b>	<b>DVD / HDP</b>			<b>VCR</b>	<b>SAT / CABLE</b>		<b>TV</b>
<b>OFF</b>	-	-	-	Power off	Power off	-	-	-	-	-
<b>ON/SOURCE</b>	-	-	-	Power on	Power on	Power on / Standby	Power on / Standby	Power on / Standby	Power on / Standby	Power on / Standby
<b>▶</b>	Play	Play / Pause	-	Play	Play	Play	Play	Punch through	Punch through	Punch through
<b>■</b>	Stop	Stop	-	Stop	Stop	Stop	Stop			
<b>SHIFT, II</b>	Pause	-	Shift	Pause	Pause	Pause	Pause			
<b>◀, SKIP + / FAVORITE</b>	Disc skip +	※ Favorites Direct	-	Disc skip	-	-	-	Punch through	Punch through	Punch through
<b>TUNING, ◀▶</b>	Manual search (fast-reverse / fast-forward)	Manual search (fast-reverse / fast-forward)	Tuning down / up	Manual search (fast-reverse / fast-forward)	Manual search (fast-reverse / fast-forward)	Manual search (fast-reverse / fast-forward)	Manual search (fast-reverse / fast-forward)			
<b>◀▶▶▶, CH +/-</b>	Auto search (cue)	Auto search (cue)	Tuner Channel - / +	Auto search (cue)	Auto search (cue)	Auto search (cue)	Switch channels (-, +)			
<b>SETUP</b>	-	-	-	Setup	Setup	-	-	-	-	-
<b>△▽◀▶</b>	-	Cursor	-	Cursor operation	Cursor operation	-	-	Cursor operation	Cursor operation	Cursor operation
<b>AUDIO</b>	-	-	-	Switching the audio signal	Switching the audio signal	-	-	-	-	-
<b>ENTER</b>	-	Enter	-	Enter setting	Enter setting	-	-	Enter setting	Enter setting	Enter setting
<b>DISPLAY</b>	-	-	-	Switching the display	Switching the display	-	-	Switching the display	Switching the display	Switching the display
<b>RETURN</b>	-	-	-	Return	Return	-	-	Return	Return	Return
<b>MENU / GUIDE</b>	-	-	-	Calling out the menus	Calling out the menus	-	-	Calling out the menus	Calling out the menus	Calling out the menus

※ The iPod/NETWORK's **FAVORITE** button can be operated when using a control dock for iPod ASD-3N/3W.

Getting Started  
Connections  
Setup  
Playback  
Remote Control  
Multi-zone  
Information  
Troubleshooting  
Specifications

□ Rear

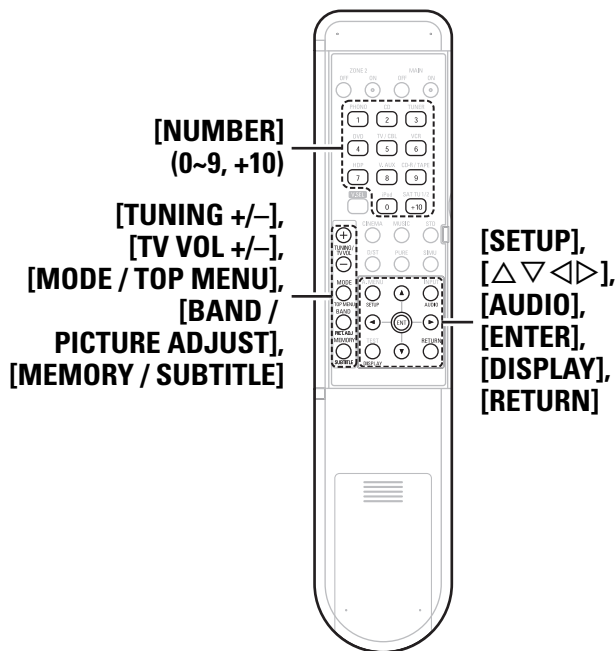

Device operated	CD Player	iPod	Tuner	DVD Player	Blu-ray Disc Player	Video Disc Player (VDP)	Video Deck	Satellite Receiver	Cable TV	TV (Monitor)
<b>SOURCE CONTROL 1</b>	<b>AUDIO</b>			<b>VIDEO</b>						
<b>SOURCE CONTROL 2</b>	<b>CD</b>	<b>iPod/NETWORK</b>	<b>TUNER</b>	<b>DVD / HDP</b>			<b>VCR</b>	<b>SAT / CABLE</b>		<b>TV</b>
<b>NUMBER (0 ~ 9, +10)</b>	–	–	–	Number input / Track selection	Number input / Track selection	Number input / Track selection	–	Channels	Channels	Channels
<b>TUNING (+, -) / TV VOL (+, -)</b>	⊕ CD Random ⊖ CD Repeat	⊕ iPod Random ⊖ iPod Repeat	⊕ Tuning up ⊖ Tuning down	⊕ DVD Random ⊖ DVD Repeat	⊕ Blu-ray Disc Random ⊖ Blu-ray Disc Repeat	⊕ TV Volume ▲ ⊖ TV Volume ▼	⊕ TV Volume ▲ ⊖ TV Volume ▼	⊕ DBS Volume ▲ ⊖ DBS Volume ▼	⊕ Cable Volume ▲ ⊖ Cable Volume ▼	⊕ TV Volume ▲ ⊖ TV Volume ▼
<b>MODE, TOP MENU</b>	–	Page search mode (once) and Browse/Remote mode switching (Press and hold)	Switch search modes	Calling out the menus	Calling out the top menus	–	–	Calling out the menus	Calling out the menus	Calling out the menus
<b>SETUP</b>	–	–	–	Setup	Setup	–	–	–	–	–
<b>Δ▽◀▶</b>	–	–	–	Cursor operation	Cursor operation	–	–	Cursor operation	Cursor operation	Cursor operation
<b>AUDIO</b>	–	–	–	Audio	Audio	–	–	–	–	–
<b>BAND, PICTURE ADJUST</b>	–	※1 Top menu	AM / FM switching	Picture adjust	Picture adjust	–	–	–	–	–
<b>ENTER</b>	–	–	–	Enter setting	Enter setting	–	–	Enter setting	Enter setting	Enter setting
<b>MEMORY, SUBTITLE</b>	–	※1 Favorite memory	Preset memory	Subtitle	Subtitle	–	–	–	–	–
<b>DISPLAY</b>	–	–	–	Switching the display	Switching the display	–	–	Switching the display	Switching the display	Switching the display
<b>RETURN</b>	–	–	–	Return	Return	–	–	Return	Return	Return
<b>Default setting (Preset code)</b>	DENON (111)	–	–	DENON (111)	※2 DENON (121)	–	HITACHI (108)	–	ABC (007)	HITACHI (134)
<b>Special Remarks</b>	①	–	–	①, ②			①	①, ③		①, ③

**[Special Remarks]**

- ① Only one device can be set in the preset memory for each mode. When a new preset code is registered, the existing code is automatically erased.
- ② For some brands, the DVD remote control buttons may have different function names. Check beforehand.
- ③ One of the following buttons can be assigned to the TV and satellite receiver or cable TV: CD, iPod/NETWORK, TUNER, DVD/HDP, VCR (☞ page 68 “Punch Through Function”).

※1: This button can be operated when using a control dock for iPod ASD-3N/3W.

※2: The initial setting of Preset code is 111 (DVD Player).

With the Blu-ray Disc Player setting, when you have set the remote controller code to “DENON2”, use the Blu-ray Disc Player preset code “121”.

[Front]

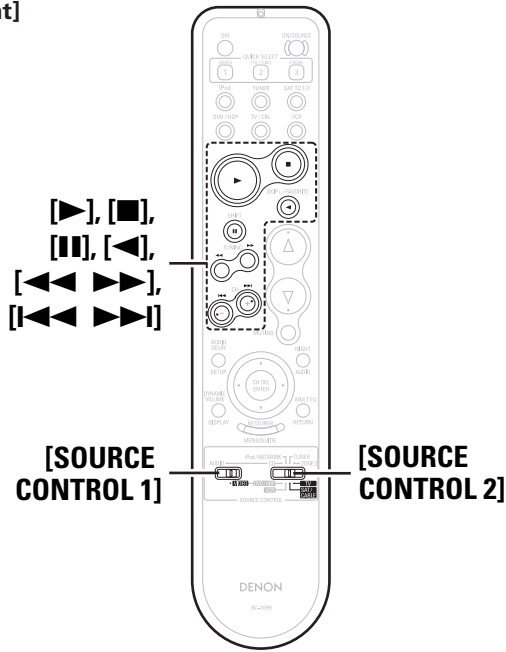

[Rear]

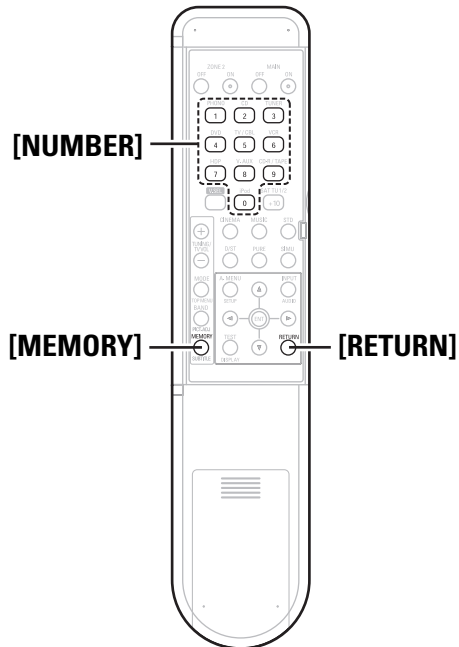

### Punch Through Function

"Punch Through" is a function allowing you to operate ▶, ■, ⏸, ◀, ◀◀, ▶▶, ◀◀◀ and ▶▶▶ on CD, iPod/NETWORK, TUNER, DVD/HDP or VCR components when in the SAT/CABLE or TV mode. By default, nothing is set.

- 1** Set [SOURCE CONTROL 1] to "VIDEO".
- 2** Set [SOURCE CONTROL 2] to the component to be registered (TV or SAT/CABLE).
- 3** Press [MEMORY] and [RETURN] at the same time. The indicator starts flashing.
- 4** Input the number of the component you want to set.

	No.
CD	1
iPod/NETWORK	2
TUNER	3
DVD/HDP	4
VCR	5
No setting	0

### Sub Remote Control Unit (RC-1107)

The sub remote control unit (RC-1107) included with the AVR-1909 can be used as the exclusive multi-zone remote control unit.

- ※ The following describes operation for the selected zone.
- Turning the multi-zone power on and off
  - Selecting the input source to be played
  - Adjusting and temporarily muting the multi-zone volume
  - Listening to the tuner (TUNER, XM and SIRIUS)
  - Operating an iPod (Note that the [FAVORITES DIRECT PLAY] button can only be used with the ASD-3N/3W.)

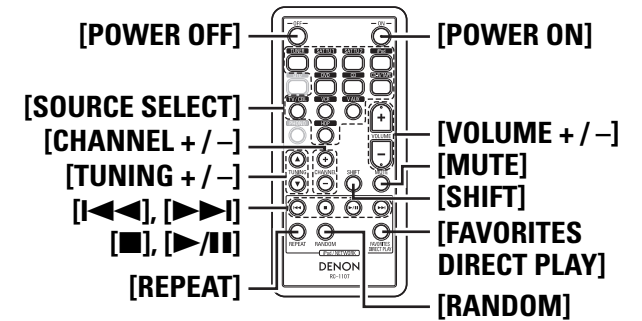

<b>POWER OFF</b>	Power off
<b>POWER ON</b>	Power on
<b>SOURCE SELECT</b>	Switching the input source
<b>VOLUME + / -</b>	Volume control
<b>CHANNEL + / -</b>	Preset channel + / -
<b>TUNING + / -</b>	Tuning + / -
<b>MUTE</b>	Muting
<b>SHIFT</b>	Switching the memory block
<b>I◀◀ ▶▶</b>	Auto search (cue)
<b>■</b>	Stop
<b>▶/⏸</b>	Play / Pause
<b>REPEAT</b>	1-track / All -track repeat play
<b>RANDOM</b>	1-track / album shuffle play

※ When using a control dock for iPod (ASD-1R), [FAVORITES DIRECT PLAY] cannot be used.

Getting Started

Connections

Setup

Playback

Remote Control

Multi-zone

Information

Troubleshooting

Specifications



# Amp Assign / Multi-zone Connections and Operations

The AVR-1909 is compatible with the following types of playback:

- **Multi-zone playback (ZONE2)**
- **Bi-amp playback (front speakers)**

**NOTE**

- For bi-amp playback, use speakers compatible with that type of connection.
- When conducting bi-amp playback, remove the short-circuiting boards (or wires) from the speaker terminals.

## Multi-zone Settings with the Amp Assign Function

The amp assign function lets you assign the amplifiers for the different channels built into the AVR-1909 to the speaker outputs for the different zones.

Select the desired playback environment from among “Setting 1” to “Setting 3”, then set the corresponding “Amp Assign” mode at menu “Manual Setup” – “Option Setup” – “Amp Assign” (page 35).

Connect the speakers as described at “Amp Assign mode setting and speakers connected to the various speaker terminals”.

**Setting 1 :**  
**● Multi-zone playback (Default Setting)**  
 5.1-channel playback + ZONE2 stereo playback

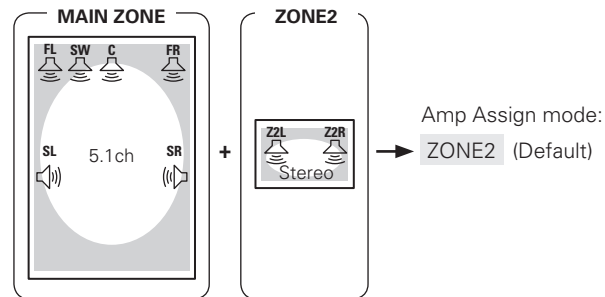

**□ Amp Assign mode setting and speakers connected to the various speaker terminals**

Speaker terminal / Amp Assign mode	FRONT		CENTER	SURROUND		SURROUND BACK / AMP ASSIGN	
	R	L		R	L	R	L
ZONE2	FR	FL	C	SR	SL	Z2R	Z2L



When ZONE2 power is on, the ZONE2 channel is output from speakers connected to the SURR.BACK/ AMP ASSIGN terminals.

**Setting 2 :**  
**● 7.1-channel playback**

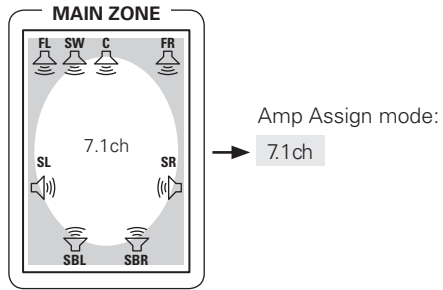

□ **Amp Assign mode setting and speakers connected to the various speaker terminals**

Speaker terminal \ Amp Assign mode	FRONT		CENTER	SURROUND		SURROUND BACK / AMP ASSIGN	
	R	L		R	L	R	L
7.1CH	FR	FL	C	SR	SL	SBR	SBL



The surround back channel is output from the speakers connected to the SURR.BACK/AMP ASSIGN terminals.

**Setting 3 :**  
**● Making bi-amp connections for the FL and FR channels in the MAIN ZONE and conducting 5.1-channel playback**  
 (switching with other modes not possible)

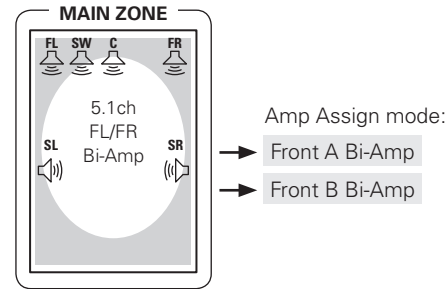

□ **Amp Assign mode setting and speakers connected to the various speaker terminals**

Speaker terminal \ Amp Assign mode	FRONT-A		FRONT-B		CENTER	SURROUND		SURROUND BACK / AMP ASSIGN	
	R	L	R	L		R	L	R	L
Front A Bi-Amp					C	SR	SL	FR	FL
Front B Bi-Amp	FR-A	FL-A	FR-B	FL-B	C	SR	SL	FR	FL



The Front A or Front B channel for Bi-Amp use is output from the speakers connected to the SURR.BACK/AMP ASSIGN terminals.

# Multi-zone Settings and Operations with Zone Output

Prepare pre-main amplifiers for ZONE2.

	Connectors for audio output	Audio signals
ZONE2	ZONE2 OUT	Stereo

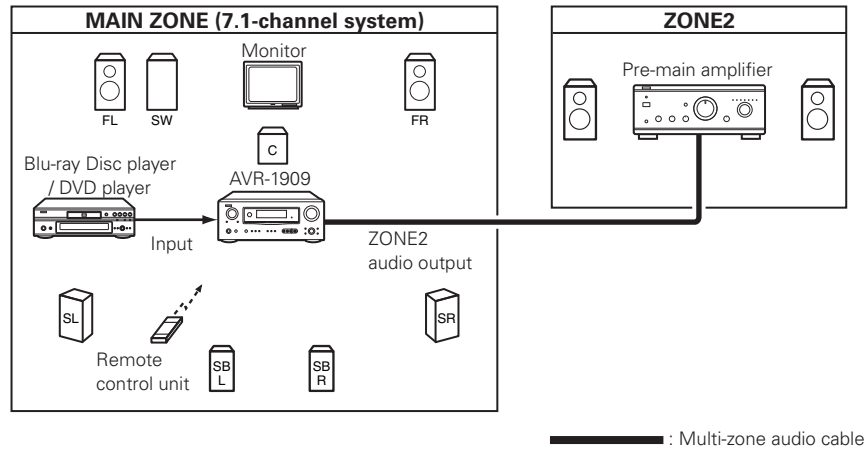

**Symbols used to indicate buttons in this manual**

Button located on both the main unit and the remote control unit → **BUTTON**  
 Button only on the main unit → **<BUTTON>**  
 Button only on the remote control unit → **[BUTTON]**

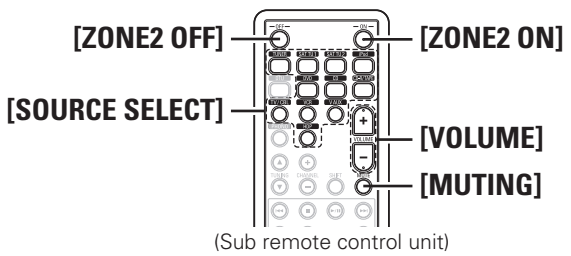
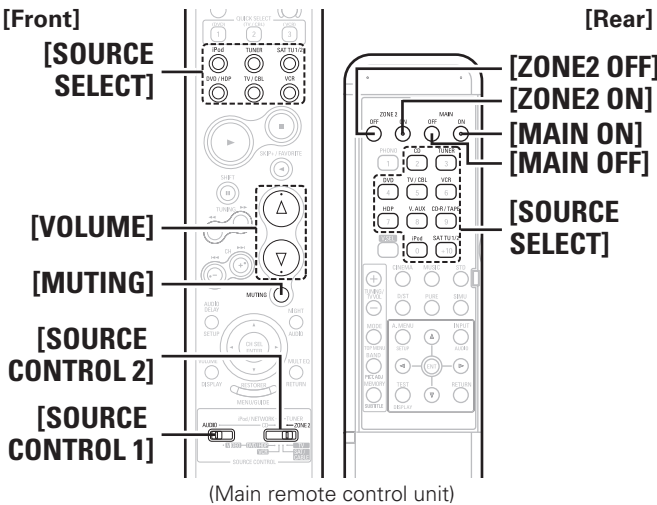
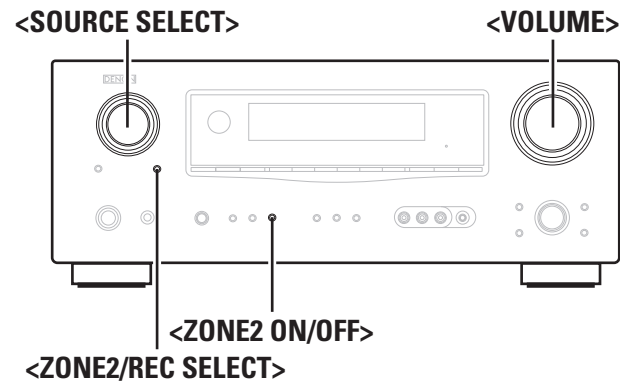

## Multi-zone Operations

### Turning the Power On and Off

#### [Operation on the main unit]

Press **<ZONE2 ON/OFF>**.  
 When the power turns on, the multi-zone indicator (**Z2**) lights on the display.

#### [Operation on the remote control unit]

Press **[ZONE2 ON]** or **[ZONE2 OFF]**.

- Also press **[SOURCE SELECT]** when in standby mode, the power turns on.
- When using ZONE2, it is possible to turn the power for the MAIN ZONE only on or off by pressing **[MAIN ON]** or **[MAIN OFF]**.

### Selecting the Input Source

#### [Operation on the main unit]

① Press **<ZONE2/REC SELECT>** and select the zone to be adjusted.  
 ② Turn **<SOURCE SELECT>**.

#### [Operation on the remote control unit]

① Set **[SOURCE CONTROL 1]** to "AUDIO" and **[SOURCE CONTROL 2]** to "ZONE2" (main remote control unit).  
 ② Press **[SOURCE SELECT]**.

### Adjusting the Volume

#### [Operation on the main unit]

① Press **<ZONE2/REC SELECT>** and select the zone to be adjusted.  
 ② Turn **<VOLUME>** to adjust.

#### [Operation on the remote control unit]

① Set **[SOURCE CONTROL 1]** to "AUDIO" and **[SOURCE CONTROL 2]** to "ZONE2" (main remote control unit).  
 ② Press **[VOLUME]**.

[Variable range] --- -70dB ~ -40dB ~ +18dB

- The volume can be increased up to the value set at menu "Manual Setup" - "ZONE2 Setup" - "Volume Limit" (page 35).
- The ZONE2 volume can be adjusted only when "ZONE2" is selected at menu "Manual Setup" - "Option Setup" - "Amp Assign" (page 35).

### Turning off the Sound Temporarily

① Set **[SOURCE CONTROL 1]** to "AUDIO" and **[SOURCE CONTROL 2]** to "ZONE2" (main remote control unit).  
 ② Press **[MUTING]**.

The sound is reduced to the level set at menu "Manual Setup" - "ZONE2 Setup" - "Mute Level" (page 35).  
 To cancel, either adjust the volume or press **[MUTING]** again.  
 The setting is canceled when the zone's power is turned off.

The source selected for ZONE2 is also output from the recording output connectors.

#### NOTE

Digital audio signals input from the COAXIAL, OPTICAL or HDMI connectors cannot be played in multi-zone.

# Other Information

## About Speaker Installation

### Surround back speakers

Sound positioning directly to the rear can be achieved easily by adding a surround back speaker to a 5.1-channel system. In addition, the acoustic image extending between the sides and the rear is narrowed, thus greatly improving the expression of the surround signals for sounds moving from the sides to the back and from the front to the point directly behind the listening position.

#### Change of positioning and acoustic image with 5.1-channel systems

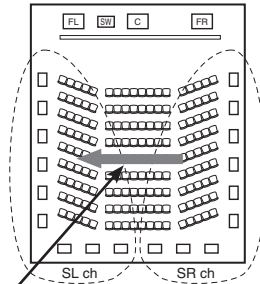

Movement of acoustic image from SR to SL

#### Change of positioning and acoustic image with 6.1-channel systems

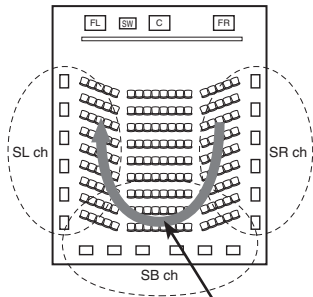

Movement of acoustic image from SR to SB to SL

In addition to sources recorded in 6.1-channels, the surround effect of conventional 2- to 5.1-channel sources can also be enhanced.

### Number of surround back speakers

We recommend using 2 speakers. When using dipolar speakers in particular, be sure to use 2 speakers.

### Placement of the surround left and right channels when using surround back speakers

We recommend installing the speakers for the surround "L" and "R" channels a bit forward.

### Examples of speaker layouts

Below we introduce examples of speaker layouts. Refer to these to arrange your speakers according to their type and how you want to use them.

#### [1] Using surround back speaker(s)

##### ① When mainly playing movies

Recommended when your surround speakers are single or 2-way speakers.

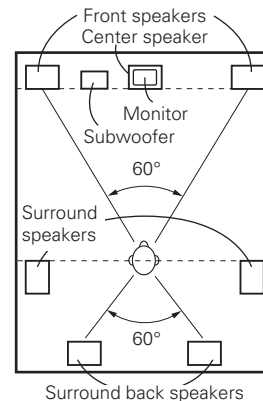

[As seen from above]

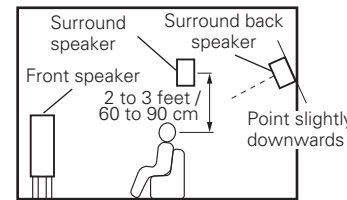

[As seen from the side]

##### ② Setting for primarily watching movies using diffusion type speakers for the surround speakers

For the greatest sense of surround sound envelopment, diffuse radiation speakers such as bipolar types, or dipolar types, provide a wider dispersion than is possible to obtain from a direct radiating speaker (monopolar). Place these speakers at either side of the prime listening position, mounted above ear level.

#### Path of the surround sound from the speakers to the listening position

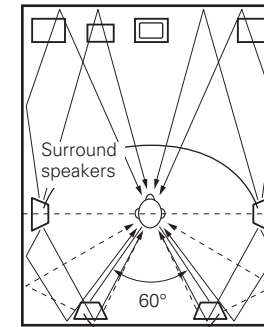

[As seen from above]

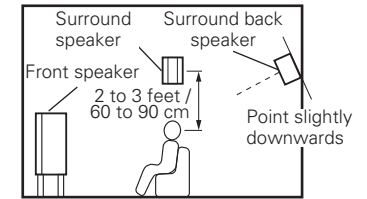

[As seen from the side]

##### ③ When playing movies and music

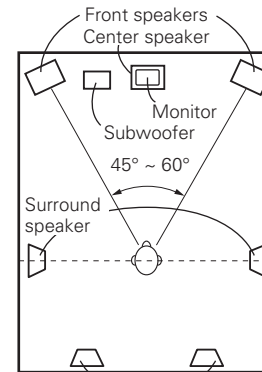

[As seen from above]

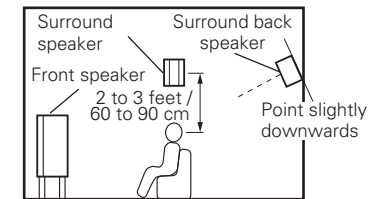

[As seen from the side]

**[2] When not using surround back speakers**

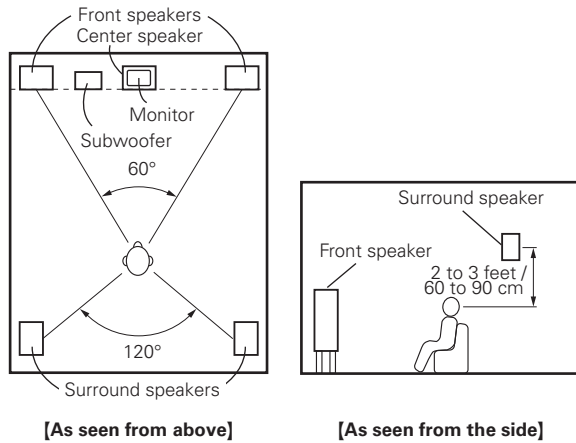

**Surround**

The AVR-1909 is equipped with a digital signal processing circuit that lets you play program sources in the surround mode to achieve the same sense of presence as in a movie theater.

**Dolby Surround**

**Dolby Digital**

Dolby Digital is a multichannel digital signal format developed by Dolby Laboratories.

A total of 5.1-channels are played: 3 front channels ("FL", "FR" and "C"), 2 surround channels ("SL" and "SR") and the "LFE" channel for low frequencies.

Because of this, there is no crosstalk between channels and a realistic sound field with a "three-dimensional" feeling (sense of distance, movement and positioning) is achieved.

A real, overpowering sense of presence is achieved when playing movie sources in AV rooms as well.

**Dolby Digital Plus**

Dolby Digital Plus is an improved Dolby Digital signal format that is compatible with up to 7.1-channels of discrete digital sound and also improves sound quality thanks to extra data bit rate performance. It is upwardly compatible with conventional Dolby Digital, so it offers greater flexibility in response to the source signal and the conditions of the playback equipment.

**Dolby TrueHD**

Dolby TrueHD is a high definition audio technology developed by Dolby Laboratories, using lossless coding technology to faithfully reproduce the sound of the studio master.

This format is compatible with a maximum sampling frequency of 96 kHz and up to 7.1-channels, so it is used for applications particularly prioritizing sound quality.

**Dolby Pro Logic II**

Dolby Pro Logic II is a matrix decoding technology developed by Dolby Laboratories.

Regular music such as that on CDs is encoded into 5-channels to achieve an excellent surround effect.

The surround channel signals are converted into stereo and full band signals (with a frequency response of 20 Hz to 20 kHz or greater) to create a "three-dimensional" sound image offering a rich sense of presence for all stereo sources.

**Dolby Pro Logic IIx**

Dolby Pro Logic IIx is a further improved version of the Dolby Pro Logic II matrix decoding technology.

Audio signals recorded in 2-channels are decoded to achieve a natural sound with up to 7.1-channels.

There are 3 modes: "Music" suited for playing music, "Cinema" suited for playing movies, and "Game" which is optimized for playing games.

Manufactured under license from Dolby Laboratories. "Dolby", "Pro Logic" and the double-D symbol are trademarks of Dolby Laboratories.

**DTS Surround**

**DTS Digital Surround**

DTS Digital Surround is the standard digital surround format of DTS, Inc., compatible with a sampling frequency of 44.1 or 48 kHz and up to 5.1-channels of digital discrete surround sound.

**DTS-HD High Resolution Audio**

DTS-HD High Resolution Audio is an improved version of the conventional DTS, DTS-ES and DTS 96/24 signals formats, compatible with sampling frequencies of 96 or 48 kHz and up to 7.1-channels of discrete digital sound. High data bit rate performance provides high quality sound. This format is fully compatible with conventional products, including conventional DTS digital surround 5.1-channel data.

**DTS-HD Master Audio**

DTS-HD Master Audio is DTS, Inc's lossless audio format compatible with up to 96 kHz/7.1-channels. The lossless audio coding technology faithfully reproduces the sound of the studio master. It is fully compatible with conventional products, including conventional DTS digital surround 5.1-channel data.

**DTS-ES™ Discrete 6.1**

DTS-ES™ Discrete 6.1 is a 6.1-channel discrete digital audio format adding a surround back (SB) channel to the DTS digital surround sound. Decoding of conventional 5.1-channel audio signals is also possible according to the decoder.

**DTS-ES™ Matrix 6.1**

DTS-ES™ Matrix 6.1 is a 6.1-channel discrete digital audio format inserting a surround back (SB) channel to the DTS digital surround sound through matrix encoding. Decoding of conventional 5.1-channel audio signals is also possible according to the decoder.

**DTS NEO:6™ Surround**

DTS NEO:6™ is a matrix decoding technology for achieving 6.1-channel surround playback with 2-channel sources. It includes "DTS NEO:6 Cinema" suited for playing movies and "DTS NEO:6 Music" suited for playing music.

Getting Started  
Connections  
Setup  
Playback  
Remote Control  
Multi-zone  
Information  
Troubleshooting  
Specifications

**DTS 96/24**

DTS 96/24 is a digital audio format enabling high sound quality playback in 5.1-channels with a sampling frequency of 96 kHz and 24 bit quantization on DVD-Video.

Manufactured under license under U.S. Patent #'s: 5,451,942; 5,956,674; 5,974,380; 5,978,762; 6,226,616; 6,487,535 & other U.S. and worldwide patents issued & pending. DTS is a registered trademark and the DTS logos, Symbol, DTS-HD and DTS-HD Master Audio are trademarks of DTS, Inc.© 1996-2007 DTS, Inc. All Rights Reserved.

**Neural Surround**

Neural Surround™, a breakthrough in audio technology, will bring the excitement of surround music to more of America's listening audience. It provides the rich envelopment and discrete image detail of surround sound in a format 100 % compatible with stereo. With superior spectral resolution and channel separation, Neural Surround™ draws the brain's attention to sonic details in musical instruments, vocals, and ambience that are typically masked by other playback systems. This allows the listener to fully experience the richness and subtleties in recorded performance as never before. As the chosen format for XM Satellite Radio's new XM HD surround programming, Neural Surround will help deliver more surround music to more listeners than any other broadcast format. XM Satellite Radio will be the first radio company to broadcast surround sound on the radio 24 hours a day and will offer three channels fully dedicated to Neural Surround™ music. This alone will amount to more than 25,000 hours of Neural Surround™ music each year.



This product is manufactured under license from Neural Audio Corporation.

D&M Holdings Inc. hereby grants the user a non-exclusive, nontransferable, limited license right exercisable to use the NA SURROUND Technology and other US and World Wide Patents Pending technology.

"Neural" and "Neural Audio" and "Neural Surround" are trademarks of Neural Audio Corporation. All Rights Reserved.

**Audyssey**

**Audyssey MultEQ®**

Audyssey MultEQ is a room equalization solution that calibrates any audio system so that it can achieve optimum performance for every listener in a large listening area. Based on several room measurements, MultEQ calculates an equalization solution that corrects for both time and frequency response problems in the listening area and also performs a fully automated surround system setup.

**Audyssey Dynamic EQ™**

Audyssey Dynamic EQ solves the problem of deteriorating sound quality as volume is decreased by taking into account human perception and room acoustics. Audyssey Dynamic EQ works in tandem with Audyssey MultEQ to provide well-balanced sound for every listener at any volume level.

**Audyssey Dynamic Volume™**

Audyssey Dynamic Volume solves the problem of large variations in volume level between television programs, commercials, and between the soft and loud passages of movies. Audyssey Dynamic EQ is integrated into Dynamic Volume so that as the playback volume is adjusted automatically, the perceived bass response, tonal balance, surround impression, and dialog clarity remain the same.



Manufactured under license from Audyssey Laboratories. U.S. and foreign patents pending. Audyssey MultEQ® is a registered trademark of Audyssey Laboratories. Audyssey Dynamic EQ™ is a trademark of Audyssey Laboratories. Audyssey Dynamic Volume™ is a trademark of Audyssey Laboratories.

**HDMI (High-Definition Multimedia Interface)**

HDMI is a digital interface standard for next generation TVs based on DVI (Digital Visual Interface) standards and optimized for use in consumer equipment.

Non-compressed digital video and multi-channel audio signals are transmitted with a single connection.

HDMI is also compatible with HDCP (High-bandwidth Digital Contents Protection), a technology for protecting copyrights that encrypts digital video signals in the same way as with DVI.

**Deep Color**

Eliminates on-screen color banding, for smooth tonal transitions and subtle gradations between colors.

Enables increased contrast ratio.

Can represent many times more shades of gray between black and white.

At 30-bit pixel depth, a four times improvement would be the minimum, and the typical improvement would be eight times or more.

**xvYCC**

Next-generation "xvYCC" color space supports 1.8 times as many colors as existing HDTV signals.

Lets HDTVs display colors more accurately.

Enables displays with natural, vivid colors.

**LipSync**

Because consumer electronics devices are using increasingly complex digital signal processing to enhance the clarity and detail of the content, synchronization of video and audio in user devices has become a greater challenge and could potentially require complex end-user adjustments. HDMI 1.3 incorporates an automatic video/audio synching capability that allows devices to perform this synchronization automatically with total accuracy.

"HDMI", "HDMI logo" and "High-Definition Multimedia Interface" are trademarks or registered trademarks of HDMI Licensing LLC.



## Surround Modes and Parameters

Surround mode	Signals and adjustability in the different modes															
	Channel output					Parameter (default values are shown in parentheses)										
	Front L/R	Center	Surround L/R	Surround Back L/R	Subwoofer	D. Comp <sup>*1</sup>	LFE <sup>*2</sup>	AFDM <sup>*1</sup>	SB CH Out	Cinema EQ.	Mode	Room Size	Effect	Delay time	Subwoofer	DRC <sup>*3</sup>
PURE DIRECT, DIRECT	○	×	×	×	⊙	○ (OFF)	○ (0dB)	×	×	×	×	×	×	×	○	○ (Auto)
MULTI CH DIRECT	○	⊙	⊙	⊙	⊙	×	○ (0dB)	○ (ON)	○	×	×	×	×	×	×	×
STEREO	○	×	×	×	⊙	○ (OFF)	○ (0dB)	×	×	×	×	×	×	×	×	○ (Auto)
EXT. IN	○	⊙	⊙	⊙	⊙	×	×	×	×	×	×	×	×	×	×	×
MULTI CH IN	○	⊙	⊙	⊙	⊙	×	○ (0dB)	○ (ON)	○	×	×	×	×	×	×	×
DOLBY PRO LOGIC IIx	○	⊙	⊙	⊙	⊙	○ (OFF)	×	×	○	○ (NOTE1)	○ (Cinema)	×	×	×	×	○ (Auto)
DOLBY PRO LOGIC II	○	⊙	⊙	×	⊙	○ (OFF)	×	×	○	○ (NOTE2)	○ (Cinema)	×	×	×	×	○ (Auto)
DTS NEO:6	○	⊙	⊙	⊙	⊙	○ (OFF)	×	×	○	○ (NOTE1)	○ (Cinema)	×	×	×	×	○ (Auto)
DOLBY DIGITAL	○	⊙	⊙	⊙	⊙	○ (OFF)	○ (0dB)	○ (ON)	○	○ (OFF)	×	×	×	×	×	○ (Auto)
DOLBY DIGITAL Plus	○	⊙	⊙	⊙	⊙	○ (OFF)	○ (0dB)	○ (ON)	○	○ (OFF)	×	×	×	×	×	×
DOLBY TrueHD	○	⊙	⊙	⊙	⊙	○ (OFF)	○ (0dB)	○ (ON)	○	○ (OFF)	×	×	×	×	×	○ (Auto)
DTS SURROUND	○	⊙	⊙	⊙	⊙	○ (OFF)	○ (0dB)	○ (ON)	○	○ (OFF)	×	×	×	×	×	×
DTS 96/24	○	⊙	⊙	⊙	⊙	○ (OFF)	○ (0dB)	○ (ON)	○	○ (OFF)	×	×	×	×	×	×
DTS-HD	○	⊙	⊙	⊙	⊙	○ (OFF)	○ (0dB)	○ (ON)	○	○ (OFF)	×	×	×	×	×	×
neural	○	⊙	⊙	⊙	⊙	×	×	×	○	×	×	×	×	×	×	×
7CH STEREO	○	⊙	⊙	⊙	⊙	○ (OFF)	○ (0dB)	×	○	×	×	×	×	×	×	×
ROCK ARENA	○	⊙	⊙	⊙	⊙	○ (OFF)	○ (0dB)	×	○	×	×	○ (Medium)	○ (10)	×	×	×
JAZZ CLUB	○	⊙	⊙	⊙	⊙	○ (OFF)	○ (0dB)	×	○	×	×	○ (Medium)	○ (10)	×	×	×
MONO MOVIE	○	⊙	⊙	⊙	⊙	○ (OFF)	○ (0dB)	×	○	×	×	○ (Medium)	○ (10)	×	×	×
VIDEO GAME	○	⊙	⊙	⊙	⊙	○ (OFF)	○ (0dB)	×	○	×	×	○ (Medium)	○ (10)	×	×	×
MATRIX	○	⊙	⊙	⊙	⊙	○ (OFF)	○ (0dB)	×	○	×	×	×	×	○ (30 ms)	×	×
VIRTUAL	○	×	×	×	⊙	○ (OFF)	○ (0dB)	×	×	×	×	×	×	×	×	×

○ : Signal / Adjustable  
 × : No signal / Not adjustable  
 ⊙ : Turned on or off by speaker configuration setting

○ : Signal / Adjustable  
 × : No signal / Not adjustable  
 NOTE1 : This parameter is available when the menu "Parameter" - "Surround Parameter" - "Mode" is set to "Cinema" (page 47).  
 NOTE2 : This parameter is available when the menu "Parameter" - "Surround Parameter" - "Mode" is set to "Cinema" or "PL" (page 47).  
**NOTE:**  
 \*1 : When playing Dolby Digital and DTS signals.  
 \*2 : When playing Dolby Digital, DTS and Linear PCM (multi ch).  
 \*3 : When playing Dolby TrueHD signal.

Getting Started  
Connections  
Setup  
Playback  
Remote Control  
Multi-zone  
Information  
Troubleshooting  
Specifications

Surround mode	Signals and adjustability in the different modes										
	Parameter (default values are shown in parentheses)										
	PRO LOGIC II/IIx MUSIC mode only			NEO:6 MUSIC mode only	EXT. IN only	Tone (NOTE5)	Night Mode (NOTE5)	MultEQ	Dynamic EQ (NOTE6)	Dynamic Volume (NOTE7)	RESTORER
	Panorama	Dimension	C. Width	Center Image	SW ATT						
PURE DIRECT, DIRECT	×	×	×	×	×	×	○ (OFF)	○ (NOTE4)	○ (NOTE4)	○ (NOTE4)	○
MULTI CH DIRECT	×	×	×	×	×	×	○ (OFF)	○ (NOTE4)	○ (NOTE4)	○ (NOTE4)	×
STEREO	×	×	×	×	×	○ (0dB)	○ (OFF)	○ (OFF)	○ (OFF)	○ (OFF)	○
EXT. IN	×	×	×	×	○	×	×	×	×	×	×
MULTI CH IN	×	×	×	×	×	○ (0dB)	○ (OFF)	○ (OFF)	○ (OFF)	○ (OFF)	×
DOLBY PRO LOGIC IIx	○ (OFF)	○ (3)	○ (3)	×	×	○ (0dB)	○ (OFF)	○ (OFF)	○ (OFF)	○ (OFF)	○
DOLBY PRO LOGIC II	○ (OFF)	○ (3)	○ (3)	×	×	○ (0dB)	○ (OFF)	○ (OFF)	○ (OFF)	○ (OFF)	○
DTS NEO:6	×	×	×	○ (0.3)	×	○ (0dB)	○ (OFF)	○ (OFF)	○ (OFF)	○ (OFF)	○
DOLBY DIGITAL	×	×	×	×	×	○ (0dB)	○ (OFF)	○ (OFF)	○ (OFF)	○ (OFF)	×
DOLBY DIGITAL Plus	×	×	×	×	×	○ (0dB)	×	○ (OFF)	○ (OFF)	○ (OFF)	×
DOLBY TrueHD	×	×	×	×	×	○ (0dB)	×	○ (OFF)	○ (OFF)	○ (OFF)	×
DTS SURROUND	×	×	×	×	×	○ (0dB)	○ (OFF)	○ (OFF)	○ (OFF)	○ (OFF)	×
DTS-96/24	×	×	×	×	×	○ (0dB)	○ (OFF)	○ (OFF)	○ (OFF)	○ (OFF)	×
DTS-HD	×	×	×	×	×	○ (0dB)	×	○ (OFF)	○ (OFF)	○ (OFF)	×
neural	×	×	×	×	×	○ (0dB)	○ (OFF)	○ (OFF)	○ (OFF)	○ (OFF)	○
7CH STEREO	×	×	×	×	×	○ (0dB)	○ (OFF)	○ (OFF)	○ (OFF)	○ (OFF)	○
ROCK ARENA	×	×	×	×	×	○ (NOTE3)	○ (OFF)	○ (OFF)	○ (OFF)	○ (OFF)	○
JAZZ CLUB	×	×	×	×	×	○ (0dB)	○ (OFF)	○ (OFF)	○ (OFF)	○ (OFF)	○
MONO MOVIE	×	×	×	×	×	○ (0dB)	○ (OFF)	○ (OFF)	○ (OFF)	○ (OFF)	○
VIDEO GAME	×	×	×	×	×	○ (0dB)	○ (OFF)	○ (OFF)	○ (OFF)	○ (OFF)	○
MATRIX	×	×	×	×	×	○ (0dB)	○ (OFF)	○ (OFF)	○ (OFF)	○ (OFF)	○
VIRTUAL	×	×	×	×	×	○ (0dB)	○ (OFF)	○ (OFF)	○ (OFF)	○ (OFF)	○

○ : Adjustable  
 × : Not adjustable  
 NOTE3 : BASS +6 dB, TREBLE +4 dB  
 NOTE4 : Can be used according to the "Audio Setup" – "EQ Preset" – "Direct Mode" setting.  
 NOTE5 : Cannot be set when the "Dynamic EQ" setting is "ON" (page 50).  
 NOTE6 : Cannot be set when the "MultEQ" setting is "OFF" (page 49).  
 NOTE7 : Cannot be set when the "Dynamic EQ" setting is "OFF" (page 50).

Differences in Surround Mode Names Depending on the Input Signals

Button	Surround mode	Note	Input signals														
			ANALOG	PCM		DTS-HD		DTS				DOLBY		DOLBY DIGITAL			
				Linear PCM (multi ch)	Linear PCM (2ch)	DTS-HD Master Audio	DTS-HD High Resolution Audio	DTS ES DSCRT (With Flag)	DTS ES MTRX (With Flag)	DTS (5.1ch)	DTS 96/24	DOLBY TrueHD	DOLBY DIGITAL Plus	DOLBY DIGITAL EX (With Flag)	DOLBY DIGITAL EX (With no Flag)	DOLBY DIGITAL (5.1/5/4ch)	DOLBY DIGITAL (4/3ch)
STANDARD																	
DTS SURROUND																	
	DTS-HD MSTR		×	×	×	●	×	×	×	×	×	×	×	×	×	×	×
	DTS-HD HI RES		×	×	×	×	●	×	×	×	×	×	×	×	×	×	×
	DTS ES DSCRT6.1	*1 *4	×	×	×	×	×	●◎	×	×	×	×	×	×	×	×	×
	DTS ES MTRX6.1	*1 *4	×	×	×	×	×	●◎	×	×	×	×	×	×	×	×	×
	DTS SURROUND		×	×	×	×	×	○	○	●	×	×	×	×	×	×	×
	DTS 96/24		×	×	×	×	×	×	×	×	●	×	×	×	×	×	×
	DTS (-HD) + PLIIx CINEMA	*2 *4	×	×	×	○	○	○	○	○	○	×	×	×	×	×	×
	DTS (-HD) + PLIIx MUSIC	*1 *4	×	×	×	○	○	○	○	○	○	×	×	×	×	×	×
	DTS (-HD) + NEO:6	*1 *4	×	×	×	○	○	×	○	○	○	×	×	×	×	×	×
	DTS NEO:6 CINEMA		○	×	○	×	×	×	×	×	×	×	×	×	×	×	○
	DTS NEO:6 MUSIC		○	×	○	×	×	×	×	×	×	×	×	×	×	×	○
DOLBY SURROUND																	
	DOLBY TrueHD		×	×	×	×	×	×	×	×	×	●	×	×	×	×	×
	DOLBY DIGITAL+		×	×	×	×	×	×	×	×	×	×	●	×	×	×	×
	DOLBY DIGITAL EX	*1 *4	×	×	×	×	×	×	×	×	×	×	×	○	○	○	×
	DOLBY (D+) (HD) +EX	*1 *4	×	×	×	×	×	×	×	×	×	○	○	×	×	×	×
	DOLBY DIGITAL		×	×	×	×	×	×	×	×	×	×	○	●	●	●	×
	DOLBY (D) (D+) (HD) +PLIIx CINEMA	*2 *4	×	×	×	×	×	×	×	×	×	○	○	●◎	○	○	×
	DOLBY (D) (D+) (HD) +PLIIx MUSIC	*1 *4	×	×	×	×	×	×	×	×	×	○	○	○	○	○	×
	DOLBY PRO LOGIC IIx CINEMA	*4	○	×	○	×	×	×	×	×	×	×	×	×	×	×	●
	DOLBY PRO LOGIC IIx MUSIC	*4	○	×	○	×	×	×	×	×	×	×	×	×	×	×	○
	DOLBY PRO LOGIC IIx GAME	*4	○	×	○	×	×	×	×	×	×	×	×	×	×	×	○
	DOLBY PRO LOGIC II CINEMA		○	×	○	×	×	×	×	×	×	×	×	×	×	×	○
	DOLBY PRO LOGIC II MUSIC		○	×	○	×	×	×	×	×	×	×	×	×	×	×	○
	DOLBY PRO LOGIC II GAME		○	×	○	×	×	×	×	×	×	×	×	×	×	×	○
	DOLBY PRO LOGIC		○	×	○	×	×	×	×	×	×	×	×	×	×	×	○

NOTE:

- \*1: This mode is not available when the surround back speaker setup is set to "None".
- \*2: This mode is not available when the surround back speaker setup is set to "1sprk" or "None".
- \*4: Cannot be set when "Amp Assign" is set to "ZONE2".

- : Mode selectable in initial status
- ◎ : Mode fixed when "AFDM" is "ON"
- : Selectable mode
- × : Non-selectable mode

Getting Started	Button		Input signals																
	Surround mode	Note	ANALOG	PCM		DTS-HD		DTS				DOLBY		DOLBY DIGITAL					
				Linear PCM (multi ch)	Linear PCM (2ch)	DTS-HD Master Audio	DTS-HD High Resolution Audio	DTS ES DSCRT (With Flag)	DTS ES MTRX (With Flag)	DTS (5.1ch)	DTS 96/24	DOLBY TrueHD	DOLBY DIGITAL Plus	DOLBY DIGITAL EX (With Flag)	DOLBY DIGITAL EX (With no Flag)	DOLBY DIGITAL (5.1/5/4ch)	DOLBY DIGITAL (4/3ch)	DOLBY DIGITAL (2ch)	
Connections	STANDARD																		
	neural		○	×	○	×	×	×	×	×	×	×	×	×	×	×	×	×	
	MULTI CH IN																		
	MULTI CH IN		×	●	×	×	×	×	×	×	×	×	×	×	×	×	×	×	×
	MULTI IN + PLIIx CINEMA		*2 *4	×	○	×	×	×	×	×	×	×	×	×	×	×	×	×	×
	MULTI IN + PLIIx MUSIC		*1 *4	×	○	×	×	×	×	×	×	×	×	×	×	×	×	×	×
Setup	MULTI CH IN 7.1		*4	×	● ◎ (7.1)	×	×	×	×	×	×	×	×	×	×	×	×	×	
	DIRECT																		
	DIRECT			○	×	○	○	○	○	○	○	○	○	○	○	○	○	○	○
	MULTI CH DIRECT			×	○	×	×	×	×	×	×	×	×	×	×	×	×	×	×
	M DIRECT + PLIIx CINEMA		*2 *4	×	○	×	×	×	×	×	×	×	×	×	×	×	×	×	×
	M DIRECT + PLIIx MUSIC		*1 *4	×	○	×	×	×	×	×	×	×	×	×	×	×	×	×	×
Playback	M DIRECT 7.1		*4	×	○	×	×	×	×	×	×	×	×	×	×	×	×	×	
	PURE DIRECT																		
	PURE DIRECT			○	×	○	○	○	○	○	○	○	○	○	○	○	○	○	○
	MULTI CH PURE DIRECT			×	○	×	×	×	×	×	×	×	×	×	×	×	×	×	×
	M PURE D + PLIIx CINEMA		*2 *4	×	○	×	×	×	×	×	×	×	×	×	×	×	×	×	×
	M PURE D + PLIIx MUSIC		*1 *4	×	○	×	×	×	×	×	×	×	×	×	×	×	×	×	×
Remote Control	M CH PURE DIRECT 7.1		*4	×	○	×	×	×	×	×	×	×	×	×	×	×	×	×	
	DSP SIMULATION																		
	7CH STEREO		*3	○	○	○	×	×	○	○	○	○	×	×	○	○	○	○	○
	ROCK ARENA			○	○	○	×	×	○	○	○	○	×	×	○	○	○	○	○
	JAZZ CLUB			○	○	○	×	×	○	○	○	○	×	×	○	○	○	○	○
	MONO MOVIE			○	○	○	×	×	○	○	○	○	×	×	○	○	○	○	○
Multi-zone	VIDEO GAME			○	○	○	×	×	○	○	○	○	×	×	○	○	○	○	
	MATRIX			○	○	○	×	×	○	○	○	○	×	×	○	○	○	○	
	VIRTUAL			○	○	○	×	×	○	○	○	○	×	×	○	○	○	○	
	STEREO																		
	STEREO			●	○	●	○	○	○	○	○	○	○	○	○	○	○	○	○
	STEREO																		

**NOTE :**

- \*1: This mode is not available when the surround back speaker setup is set to "None".
- \*2: This mode is not available when the surround back speaker setup is set to "1spkr" or "None".
- \*3: If the surround back speaker setup is set to "None", then "5CH STEREO" is displayed.
- \*4: Cannot be set when "Amp Assign" is set to "ZONE2".

- : Mode selectable in initial status
- ◎ : Mode fixed when "AFDM" is "ON"
- : Selectable mode
- × : Non-selectable mode

# Relationship Between Video Signals and Monitor Output

Video convert	Input signals				Monitor output			
	HDMI	COMPONENT	S-VIDEO	VIDEO	HDMI	COMPONENT	S-VIDEO	VIDEO
ON	×	×	×	×	×	×	×	×
	×	×	×	○	VIDEO	VIDEO	VIDEO	VIDEO
	×	×	○	×	S-VIDEO	S-VIDEO	S-VIDEO	S-VIDEO
	×	×	○	○	S-VIDEO	S-VIDEO	S-VIDEO	S-VIDEO
	×	○ (1080p)	×	×	×	COMPONENT	×	×
	×	○ (480p ~ 720p)	×	×	COMPONENT	COMPONENT	×	×
	×	○ (480i / 576i)	×	×	COMPONENT	COMPONENT	COMPONENT	COMPONENT
	×	○ (1080p)	×	○	VIDEO	COMPONENT*1	VIDEO	VIDEO
	×	○ (480p ~ 720p)	×	○	COMPONENT*1	COMPONENT*1	×	VIDEO
	×	○ (480i / 576i)	×	○	COMPONENT*1	COMPONENT*1	COMPONENT	VIDEO
	×	○ (1080p)	○	×	S-VIDEO	COMPONENT*2	S-VIDEO	S-VIDEO
	×	○ (480p ~ 720p)	○	×	COMPONENT*2	COMPONENT*2	S-VIDEO	S-VIDEO
	×	○ (480i / 576i)	○	×	COMPONENT*2	COMPONENT*2	S-VIDEO	S-VIDEO
	×	○ (1080p)	○	○	S-VIDEO	COMPONENT*2	S-VIDEO	S-VIDEO
	×	○ (480p ~ 720p)	○	○	COMPONENT*2	COMPONENT*2	S-VIDEO	S-VIDEO
	×	○ (480i / 576i)	○	○	COMPONENT*2	COMPONENT*2	S-VIDEO	S-VIDEO
	○	×	×	×	HDMI	×	×	×
	○	×	×	○	HDMI*1	VIDEO	VIDEO	VIDEO
	○	×	○	×	HDMI*2	S-VIDEO	S-VIDEO	S-VIDEO
	○	×	○	○	HDMI*2	S-VIDEO	S-VIDEO	S-VIDEO
	○	○ (Other than 480i / 576i)	×	×	HDMI	COMPONENT	×	×
	○	○ (480i / 576i)	×	×	HDMI	COMPONENT	COMPONENT	COMPONENT
	○	○ (1080p)	×	○	HDMI*1	COMPONENT*1	VIDEO	VIDEO
	○	○ (480p ~ 720p)	×	○	HDMI*1	COMPONENT*1	×	VIDEO
	○	○ (480i / 576i)	×	○	HDMI*1	COMPONENT*1	COMPONENT	VIDEO
	○	○ (Other than 480i / 576i)	○	×	HDMI*2	COMPONENT*2	S-VIDEO	S-VIDEO
	○	○ (480i / 576i)	○	×	HDMI*2	COMPONENT*2	S-VIDEO	S-VIDEO
	○	○ (Other than 480i / 576i)	○	○	HDMI*2	COMPONENT*2	S-VIDEO	S-VIDEO
○	○ (480i / 576i)	○	○	HDMI*2	COMPONENT*2	S-VIDEO	S-VIDEO	

○ : Signal input  
 × : No signal  
 480p ~ 720p: 480p / 576p / 1080i / 720p

× : Not output  
 \*1 : On-screen display superimposed on video signal and output.  
 \*2 : On-screen display superimposed on S-Video signal and output.

COMPONENT or HDMI:  
 On-screen display only displayed for the **MENU** button on the main unit or the **A.MENU** button on the main remote control unit.  
 ■ : Video signals are not output when the analog to HDMI convert function is set to "OFF".

- The MAIN ZONE video conversion function is compatible with the following format: NTSC, PAL, SECAM, NTSC4.43, PAL-N, PAL-M and PAL-60.
- When SECAM signals of video input are up-converted, the signals are output in PAL format from the S-Video connector.
- When the input signal is a component 1080i or 720p signal, the signal upconverted to HDMI is output with that resolution or 1080p.
- When the input signal is a video, S-Video or component 480i, 480p, 576i or 576p signals, the signal up-converted to HDMI is output according to the setting made at "Resolution" under "Input Setup" - "Video" - "Resolution" (page 40).

Getting Started  
Connections  
Setup  
Playback  
Remote Control  
Multi-zone  
Information  
Troubleshooting  
Specifications

Video convert	S-VIDEO MONITOR OUT	Input signals				Monitor output			
		HDMI	COMPONENT	S-VIDEO	VIDEO	HDMI	COMPONENT	S-VIDEO	VIDEO
OFF	—	×	×	×	×	×	×	×	×
	—	×	×	×	○	×	×	×	VIDEO
	—	×	×	○	×	×	×	S-VIDEO	×
	Used	×	×	○	○	×	×	S-VIDEO	VIDEO *2
	Not used	×	×	○	○	×	×	—	VIDEO
	—	×	○	×	×	×	COMPONENT	×	×
	—	×	○	×	○	×	COMPONENT*1	×	VIDEO
	—	×	○	○	×	×	COMPONENT*2	S-VIDEO	×
	Used	×	○	○	○	×	COMPONENT*2	S-VIDEO	VIDEO *2
	Not used	×	○	○	○	×	COMPONENT*1	—	VIDEO
	—	○	×	×	×	HDMI	×	×	×
	—	○	×	×	○	HDMI	×	×	VIDEO
	—	○	×	○	×	HDMI	×	S-VIDEO	×
	Used	○	×	○	○	HDMI	×	S-VIDEO	VIDEO *2
	Not used	○	×	○	○	HDMI	×	—	VIDEO
	—	○	○	×	×	HDMI	COMPONENT	×	×
	—	○	○	×	○	HDMI	COMPONENT*1	×	VIDEO
	—	○	○	○	×	HDMI	COMPONENT*2	S-VIDEO	×
	Used	○	○	○	○	HDMI	COMPONENT*2	S-VIDEO	VIDEO *2
	Not used	○	○	○	○	HDMI	COMPONENT*1	—	VIDEO

○ : Signal input  
× : No signal

× : Not output  
\*1 : On-screen display superimposed on video signal and output.  
\*2 : On-screen display superimposed on S-Video signal and output.  
COMPONENT or HDMI:  
On-screen display only displayed for the **MENU** button on the main unit or the **A.MENU** button on the main remote control unit.

# Troubleshooting

If a problem should arise, first check the following:

1. Are the connections correct?
2. Is the set being operated as described in the owner's manual?
3. Are the other components operating properly?

If this unit does not operate properly, check the items listed in the table below. Should the problem persist, there may be a malfunction.

In this case, disconnect the power immediately and contact your store of purchase.

**[General]**

Symptom	Cause	Countermeasure	Page
Set does not operate properly.	<ul style="list-style-type: none"> <li>External noise or interference is causing the set to malfunction.</li> </ul>	<ul style="list-style-type: none"> <li>Reset the microprocessor.</li> </ul>	64
Power does not turn on, or turns off directly after it was turned on.	<ul style="list-style-type: none"> <li>Connection of the power cord is faulty.</li> </ul>	<ul style="list-style-type: none"> <li>Check the insertion of the power cord plug.</li> </ul>	21
No sound is produced from speakers.	<ul style="list-style-type: none"> <li>Connection with the input devices or connection of the speaker cables is faulty.</li> <li>Device you want to play and set input source do not match.</li> <li>Master volume is turned too low.</li> <li>Mute mode is set.</li> <li>Headphones are connected.</li> <li>No digital signals are being input.</li> </ul>	<ul style="list-style-type: none"> <li>Check the connections.</li> </ul>	10
		<ul style="list-style-type: none"> <li>Select an appropriate input source.</li> </ul>	54
		<ul style="list-style-type: none"> <li>Adjust the master volume to an appropriate level.</li> </ul>	54
		<ul style="list-style-type: none"> <li>Cancel the mute mode.</li> <li>Disconnect the headphones.</li> </ul>	54
		<ul style="list-style-type: none"> <li>Select an input source for which the digital input setting has been made.</li> </ul>	42
<ul style="list-style-type: none"> <li>The connectors to which the digital inputs are assigned and the settable input modes do not match.</li> </ul>	<ul style="list-style-type: none"> <li>Set the input mode.</li> </ul>	41	
Display is off.	<ul style="list-style-type: none"> <li>The "Dimmer" setting is set to "OFF".</li> <li>The PURE DIRECT mode is set.</li> </ul>	<ul style="list-style-type: none"> <li>Set to something other than "OFF".</li> </ul>	37
		<ul style="list-style-type: none"> <li>Set a surround mode other than the PURE DIRECT mode.</li> </ul>	46

Symptom	Cause	Countermeasure	Page
"DOLBY DIGITAL" indicator does not appear on display.	<ul style="list-style-type: none"> <li>Blu-ray Disc player / DVD player's digital audio output setting is not proper.</li> </ul>	<ul style="list-style-type: none"> <li>Check the Blu-ray Disc player / DVD player's audio output setting. For details, read the Blu-ray Disc player / DVD player's operating instructions.</li> </ul>	-
Power switches off suddenly while you are using the AVR-1909, the power indicator will flash in red at intervals of approximately 2 seconds.	<ul style="list-style-type: none"> <li>The protection circuit will be activated depending upon the temperature rise in the internal parts of the unit.</li> </ul>	<ul style="list-style-type: none"> <li>Please switch off power at once, and re-apply the power after the body temperature has fallen sufficiently.</li> </ul>	11
		<ul style="list-style-type: none"> <li>Please re-install AVR-1909 in a place having good ventilation.</li> </ul>	-
Power switches off suddenly while you are using the AVR-1909, the power indicator will flash red at intervals of approximately 0.5 seconds.	<ul style="list-style-type: none"> <li>Use speakers having impedance less than that specified.</li> <li>If speaker cable core wires touch each other or the core wires become disconnected from their terminals, the protection circuit will be activated in the event of core wires coming into contact with the AVR-1909 rear panel.</li> </ul>	<ul style="list-style-type: none"> <li>Please use speakers which have the specified impedance.</li> </ul>	11
		<ul style="list-style-type: none"> <li>Unplug the power cord, then after twisting the core wires together tightly again, or effecting termination treatments etc, please reconnect once again.</li> </ul>	11
Even applying power, the power display flashes red at intervals of approximately 0.5 seconds.	<ul style="list-style-type: none"> <li>The AVR-1909 amplifier circuit has failed.</li> </ul>	<ul style="list-style-type: none"> <li>Switch off the power and please contact the DENON service adviser.</li> </ul>	-



**[Remote Control Unit]**

Symptom	Cause	Countermeasure	Page
Set does not work properly when remote control unit operated.	• Batteries are worn.	• Replace with new batteries.	3
	• You are operating outside of the specified range.	• Operate within the specified range.	3
	• Obstacle between main unit and remote control unit.	• Remove the obstacle.	3
	• The batteries are not inserted in the proper direction, as indicated by the polarity marks in the battery compartment.	• Insert the batteries in the proper direction, following the polarity marks in the battery compartment.	3
	• The set's remote control sensor is exposed to strong light (direct sunlight, inverter type fluorescent bulb light, etc.).	• Move the set to a place in which the remote control sensor will not be exposed to strong light.	3
• The remote ID of the main unit and remote control unit do not match.	• Set "Remote ID" for the main unit to "1".	36	

**[Audio]**

Symptom	Cause	Countermeasure	Page
No sound is produced from center speaker.	• You are playing a monaural source (TV, AM radio broadcast, etc.) in the "STANDARD" (Dolby/DTS Surround) mode.	• The mode is set to something other than "STANDARD" (Dolby/DTS Surround).	45
No sound is produced from surround speakers.	• The surround mode is set to "STEREO", "DIRECT" or "PURE DIRECT".	• Set to a surround playback mode.	45, 46
No sound is produced from surround back speaker.	• The surround back speaker's power amplifier is assigned to a different channel.	• Check the setting and change it as necessary.	35
	• Surround back speaker setting is set to "None".	• Set to something other than "None".	30
	• The "Parameter" – "Surround Parameter" – "SB CH Out" settings are "OFF".	• Please set "Parameter" – "Surround Parameter" – "SB CH Out" to settings other than "OFF".	48, 49
• Surround mode not set to a mode for 6.1- or 7.1-channel playback.	• Select a surround playback mode.	44 ~ 46	

Symptom	Cause	Countermeasure	Page
No sound is produced from subwoofer.	• Subwoofer's power not turned on.	• Turn on the subwoofer's power.	–
	• The "Subwoofer" setting at "Speaker Configuration" is set to "No".	• Set to "Yes".	29
No test tones are produced when main remote control unit's TEST button is pressed.	• The subwoofer is not properly connected.	• Check the connections.	10
	• The subwoofer's volume is turned off.	• Adjust the subwoofer's volume to an appropriate level.	63
No test tones are produced when main remote control unit's TEST button is pressed.	• Surround mode not set to "STANDARD" (Dolby/DTS Surround).	• Set to the "STANDARD" (Dolby/DTS Surround) mode.	45
	• Surround mode not set to "STANDARD" (Dolby/DTS Surround).	• Set to the "STANDARD" (Dolby/DTS Surround) mode.	45
DTS sound is not output.	• Blu-ray Disc player / DVD player's audio output setting is not set to bitstream.	• Set the Blu-ray Disc player / DVD player. For details, refer to the Blu-ray Disc player / DVD player's operating instructions.	–
	• Blu-ray Disc player / DVD player is not compatible with DTS sound playback.	• Use a DTS-compatible player.	–
HDMI audio signals are not output from speakers.	• The AVR-1909's "Decode Mode" setting is set to "PCM".	• Set to the "Auto" or "DTS" mode.	41
	• The "Manual Setup" – "HDMI Setup" – "HDMI Audio Out" setting is set to "TV".	• Set to "AMP".	32
No sound is output from the monitor connected with HDMI connections.	• The "Manual Setup" – "HDMI Setup" – "HDMI Audio Out" setting is set to "AMP".	• Set to "TV".	32
Dolby TrueHD, DTS-HD, Dolby Digital Plus audio is not output.	• HDMI is not connected.	• Connect the HDMI.	12, 13
	• Blu-ray Disc player's audio output setting is not set to bitstream.	• Set the Blu-ray Disc player. For details, refer to the Blu-ray Disc player's operating instructions.	–
• Blu-ray Disc player is not compatible with DTS sound playback.	• Use a DTS-compatible player.	–	

[Video]

Symptom	Cause	Countermeasure	Page
No picture appears.	<ul style="list-style-type: none"> <li>The connections between the AVR-1909 and monitor are faulty.</li> <li>The monitor's input setting is wrong.</li> <li>PURE DIRECT mode is set.</li> <li>The player is connected using the component input connectors, the monitor is connected using the video (yellow) or S-Video output connectors.</li> </ul>	<ul style="list-style-type: none"> <li>Check the connections.</li> </ul>	12 ~ 16
		<ul style="list-style-type: none"> <li>Set properly.</li> </ul>	-
		<ul style="list-style-type: none"> <li>Cancel the PURE DIRECT mode.</li> <li>High definition (1080i/720p) and progressive (480p/576p) video signals are not down-converted. Set the player to interlace (480i/576i) signals.</li> </ul>	46 -
Picture cannot be recorded.	<ul style="list-style-type: none"> <li>Input source does not match recorder's video connection connector (video or S-Video).</li> </ul>	<ul style="list-style-type: none"> <li>The video conversion function does not work for the REC OUT connectors. Match the input source and recorder connections.</li> </ul>	15
DVDs cannot be copied on a VCR.	-	<ul style="list-style-type: none"> <li>This is not a malfunction. Most movie software includes copy prevention signals and cannot be copied.</li> </ul>	-
On-screen display is not shown.	<ul style="list-style-type: none"> <li>The operation content display is "OFF".</li> <li>The main volume display is "OFF".</li> <li>The display during tuner operation is "OFF".</li> <li>The display during iPod operation is "OFF".</li> </ul>	<ul style="list-style-type: none"> <li>When viewing HDMI or component video signals via the AVR-1909, the on-screen display appears when the <b>MENU</b> button on the main unit or the <b>A.MENU</b> button on the main remote control unit.</li> </ul>	9
		<ul style="list-style-type: none"> <li>When only HDMI or component video signals are input to the AVR-1909, the characters of the on-screen display are not displayed over the picture.</li> </ul>	9
		<ul style="list-style-type: none"> <li>Set "Manual Setup" - "Option Setup" - "On-Screen Display" - "Text" to "ON".</li> </ul>	36
		<ul style="list-style-type: none"> <li>Set "Manual Setup" - "Option Setup" - "On-Screen Display" - "Master Volume" to "ON".</li> </ul>	36
		<ul style="list-style-type: none"> <li>Set when "Manual Setup" - "On-Screen Display" - "Tuner Information" is not "OFF".</li> </ul>	36
<ul style="list-style-type: none"> <li>Set when "Manual Setup" - "On-Screen Display" - "iPod Information" is not "OFF".</li> </ul>	36		

[HDMI]

Symptom	Cause	Countermeasure	Page
HDMI audio signals are not output from speakers.	<ul style="list-style-type: none"> <li>The "Manual Setup" - "HDMI Setup" - "HDMI Audio Out" setting is set to "TV"</li> </ul>	<ul style="list-style-type: none"> <li>Set to "Amp"</li> </ul>	32
No picture appears with HDMI connections.	<ul style="list-style-type: none"> <li>The connections to the HDMI connectors are faulty.</li> <li>HDMI input setting is improper.</li> <li>The monitor is not compatible with copyright protection (HDCP).</li> <li>The HDMI format of the player and monitor do not match.</li> </ul>	<ul style="list-style-type: none"> <li>Check the connections.</li> </ul>	12
		<ul style="list-style-type: none"> <li>Check the HDMI input setting.</li> <li>Connect a monitor that is compatible with copyright protection (HDCP).</li> </ul>	42 12
		<ul style="list-style-type: none"> <li>Match the HDMI format of the player and monitor.</li> </ul>	12
No sound is output from the monitor connected with HDMI connections.	<ul style="list-style-type: none"> <li>The "Manual Setup" - "HDMI Setup" - "HDMI Audio Out" setting is set to "Amp".</li> </ul>	<ul style="list-style-type: none"> <li>Set to "TV".</li> </ul>	32
When performing the following operations on a connected device, AVR-1909 has the same operations. ·Power ON/OFF ·Switching audio output devices ·Adjust volume ·Switch input source	<ul style="list-style-type: none"> <li>HDMI's CEC function is operating.</li> </ul>	<ul style="list-style-type: none"> <li>Set "Manual Setup" - "HDMI Setup" - "HDMI Control" to "OFF". When you only want to operate the power on/off each device, set "Power Off Control" to "OFF".</li> </ul>	32

**[iPod]**

Symptom	Cause	Countermeasure	Page
iPod cannot be played.	<ul style="list-style-type: none"> <li>The input source assigned to "iPod dock" is not selected.</li> <li>Cable is not properly connected.</li> <li>Control dock for iPod's AC adapter is not connected to power outlet.</li> </ul>	<ul style="list-style-type: none"> <li>Switch to the input source assigned at "iPod dock".</li> <li>Reconnect.</li> <li>Plug the control dock for iPod's AC adapter into a power outlet.</li> </ul>	42 14 -

**[XM Satellite Radio]**

Symptom	Cause	Countermeasure	Page
"CHECK XM TUNER" is displayed.	<ul style="list-style-type: none"> <li>The XM Mini-Tuner is not installed or not fully seated in the XM Mini-Tuner Dock or the XM Mini-Tuner dock is not connected to the AVR-1909.</li> </ul>	<ul style="list-style-type: none"> <li>Confirm the XM Mini-Tuner is fully seated in the dock and check the XM Mini-Tuner dock cable is connected to the AVR-1909.</li> </ul>	17
"CHECK ANTENNA" is displayed.	<ul style="list-style-type: none"> <li>AVR-1909's XM connector and the XM Mini-Tuner and Home Dock is not properly connected.</li> </ul>	<ul style="list-style-type: none"> <li>Check that the connections are correct.</li> </ul>	56
"NO SIGNAL" is displayed.	<ul style="list-style-type: none"> <li>The signal cannot be received.</li> </ul>	<ul style="list-style-type: none"> <li>Reposition your XM Mini-Tuner and Home Dock antenna.</li> </ul>	-
"OFF AIR" is displayed.	<ul style="list-style-type: none"> <li>The selected channel is not currently broadcasting.</li> </ul>	<ul style="list-style-type: none"> <li>Select another channel.</li> </ul>	-
Receiving only XM channels 0 and 1.	<ul style="list-style-type: none"> <li>The XM Tuner is not activated.</li> </ul>	<ul style="list-style-type: none"> <li>Contact XM Radio.</li> </ul>	-
"XM ---" is displayed.	<ul style="list-style-type: none"> <li>The selected channel is not available. The channel may have been reassigned to a different channel number. This message may occur initially with a new radio or a radio that has not received XM's signal for an extended period.</li> </ul>	<ul style="list-style-type: none"> <li>Consult the latest channel guide at <a href="http://www.xmradio.com">www.xmradio.com</a> for the current list of channels. For cases of a new radio or a radio that has not received XM's signal for an extended period, allow the radio to receive the XM satellite signal for at least 5 minutes and then try to select the channel again.</li> </ul>	-
"CH UNAVAILABLE" is displayed.	<ul style="list-style-type: none"> <li>Channel is not present.</li> </ul>	<ul style="list-style-type: none"> <li>Select another channel.</li> </ul>	-
"CH UNAUTHORIZED" is displayed.	<ul style="list-style-type: none"> <li>You selected an XM channel that is blocked or cannot be receive with your XM subscription package.</li> </ul>	<ul style="list-style-type: none"> <li>Consult the latest channel guide at <a href="http://www.xmradio.com">www.xmradio.com</a> for the current list of channels. For information on receiving this channel, visit <a href="http://www.xmradio.com">www.xmradio.com</a> or contact XM Satellite Radio at 1-800-967-2346.</li> </ul>	-

**[SIRIUS Satellite Radio]**

Symptom	Cause	Countermeasure	Page
"CHECK SIRIUS TUNER" is displayed.	<ul style="list-style-type: none"> <li>The Sirius Tuner unit is not connected.</li> </ul>	<ul style="list-style-type: none"> <li>Check that the connections are correct.</li> </ul>	18
"ANTENNA ERROR" is displayed.	<ul style="list-style-type: none"> <li>If the Sirius Tuner is not connected, it will be broken.</li> </ul>	<ul style="list-style-type: none"> <li>Check that the connections are correct.</li> </ul>	18
"NO SIGNAL" is displayed.	<ul style="list-style-type: none"> <li>The signal cannot be received.</li> </ul>	<ul style="list-style-type: none"> <li>Reposition your SiriusConnect Home Tuner antenna.</li> </ul>	-
"INVALID CHANNEL" is displayed.	<ul style="list-style-type: none"> <li>Channel is not present.</li> </ul>	<ul style="list-style-type: none"> <li>Select another channel.</li> </ul>	-
"NO CHANNEL AVAILABLE" is displayed.	<ul style="list-style-type: none"> <li>Even searching categories, if none of the channels are present, the "Parental Lock" is on (locked).</li> </ul>	<ul style="list-style-type: none"> <li>Please search for other categories.</li> </ul>	-
"ACQUIRING SIGNAL" is displayed.	<ul style="list-style-type: none"> <li>The selected channel is not currently broadcasting.</li> <li>Displays while SiriusConnect Home Tuner is connected.</li> </ul>	<ul style="list-style-type: none"> <li>Select another channel.</li> </ul>	-
"Call SIRIUS" * is displayed.	<ul style="list-style-type: none"> <li>Channels are not subscribed to.</li> </ul>	<ul style="list-style-type: none"> <li>If you subscribe to the channel, you can receive the channel.</li> </ul>	-
"SUBSCRIPTION UPDATED" is displayed.	<ul style="list-style-type: none"> <li>While updating contract information.</li> </ul>	-	-
"Enter Lock Code [ ]" is displayed.	<ul style="list-style-type: none"> <li>Selected channels are locked.</li> </ul>	<ul style="list-style-type: none"> <li>Please insert pass word (4 digits) into "[ ]".</li> </ul>	-

\* : After scroll displays "Call 888-539-..." twice, displays "Call SIRIUS".

# Specifications

## Audio section

### Power amplifier

#### Rated output:

Front (A, B):  
 90 W + 90 W (8 Ω/ohms, 20 Hz ~ 20 kHz with 0.08 % T.H.D.)  
 120 W + 120 W (6 Ω/ohms, 1 kHz with 0.7 % T.H.D.)  
 Center:  
 90 W (8 Ω/ohms, 20 Hz ~ 20 kHz with 0.08 % T.H.D.)  
 120 W (6 Ω/ohms, 1 kHz with 0.7 % T.H.D.)

#### Surround:

90 W + 90 W (8 Ω/ohms, 20 Hz ~ 20 kHz with 0.08 % T.H.D.)  
 120 W + 120 W (6 Ω/ohms, 1 kHz with 0.7 % T.H.D.)

#### Surround Back:

90 W + 90 W (8 Ω/ohms, 20 Hz ~ 20 kHz with 0.08 % T.H.D.)  
 120 W + 120 W (6 Ω/ohms, 1 kHz with 0.7 % T.H.D.)

#### Output connectors:

Front: A or B 6 ~ 16 Ω/ohms  
 A + B 12 ~ 16 Ω/ohms  
 Center, Surround, Surround Back: 6 ~ 16 Ω/ohms

### Analog

#### Input sensitivity / Input impedance:

200 mV / 47 kΩ/kohms

#### Frequency response:

10 Hz ~ 100 kHz — +1, -3 dB (DIRECT mode)

#### S/N:

100 dB (IHF-A weighted, DIRECT mode)

#### Distortion:

0.008 % (20 Hz ~ 20 kHz) (DIRECT mode)

#### Rated output:

1.2 V

## Video section

### Standard video connectors

#### Input / output level and impedance:

1 Vp-p, 75 Ω/ohms

#### Frequency response:

5 Hz ~ 10 MHz — +1, -3 dB (when video convert set to "OFF")

### S-Video connectors

#### Input / output level and impedance:

Y (brightness) signal — 1 Vp-p, 75 Ω/ohms

C (color) signal — 0.286 Vp-p, 75 Ω/ohms

#### Frequency response:

5 Hz ~ 10 MHz — +1, -3 dB (when video convert set to "OFF")

### Color component video connector

#### Input / output level and impedance:

Y (brightness) signal — 1 Vp-p, 75 Ω/ohms

P<sub>B</sub> / C<sub>B</sub> signal — 0.7 Vp-p, 75 Ω/ohms

P<sub>R</sub> / C<sub>R</sub> signal — 0.7 Vp-p, 75 Ω/ohms

#### Frequency response:

5 Hz ~ 60 MHz — +0, -3 dB (when video convert set to "OFF")

## Tuner section

### Receiving Range:

[FM]  
 (note: μV at 75 Ω/ohms, 0 dBf = 1 x 10<sup>15</sup> W)  
 87.5 MHz ~ 107.9 MHz

### Usable Sensitivity:

1.0 μV (11.2 dBf)

### 50 dB Quieting Sensitivity:

MONO 1.6 μV (15.3 dBf)

STEREO 23 μV (38.5 dBf)

### S/N (IHF-A):

MONO 77 dB

STEREO 72 dB

### Total harmonic Distortion (at 1 kHz):

MONO 0.15 %

STEREO 0.3 %

### [AM]

520 kHz ~ 1710 kHz

18 μV

## General

### Power supply:

AC 120 V, 60 Hz

### Power consumption:

5.2 A

0.3 W (Standby)

### Maximum external dimensions:

434 (W) x 171 (H) x 377 (D) mm (17-3/32" x 6-47/64" x 14-27/32")

### Weight:

11.5 kg (25 lbs 5.7 oz)

## Main remote control unit (RC-1099)

### Batteries:

R6/AA Type (two batteries)

### Maximum external dimensions:

52 (W) x 243 (H) x 21 (D) mm (2-3/64" x 9-9/16" x 53/64")

### Weight:

184 g (Approx 6.5 oz) (including batteries)

## Sub remote control unit (RC-1107)

### Batteries:

R03/AAA Type (two batteries)

### Maximum external dimensions:

54 (W) x 115 (H) x 23 (D) mm (2-1/8" x 4-17/32" x 29/32")

### Weight:

80 g (Approx 2.8 oz) (including batteries)

\* For purposes of improvement, specifications and design are subject to change without notice.

## List of preset codes / Liste de codes pré-régulés

### DVD Player/Bul-Ray Disc Player

<b>A</b>	Aiwa	009
<b>D</b>	Denon	014, [111]*, 121
<b>H</b>	Hitachi	010
<b>J</b>	JVC	006, 011
<b>K</b>	Konka	012, 013
<b>M</b>	Magnavox	005
	Mitsubishi	004
<b>P</b>	Panasonic	014
	Philips	005, 015, 016, 017
	Pioneer	003, 008
<b>S</b>	Sanyo	018
	Sony	002, 019, 020
<b>T</b>	Toshiba	001, 021, 022
<b>Z</b>	Zenith	023

### VDP

<b>D</b>	Denon	028, 029, 112
<b>M</b>	Magnavox	026
	Mitsubishi	028
<b>P</b>	Panasonic	029, 030
	Philips	026
	Pioneer	028, 031
<b>R</b>	RCA	032
<b>S</b>	Sony	033, 034, 035, 036

### VCR

<b>A</b>	Admiral	081
	Aiko	095
	Aiwa	009
	Akai	026, 027, 070, 072, 082, 083, 084
	Alba	055
	Amstrad	009
	ASA	042
	Asha	087
	Audio Dynamic	005, 085
	Audiovox	088
	Beaumarck	087
	Broksonic	086, 093
<b>C</b>	Calix	088
	Candle	006, 087, 088, 089, 090
	Canon	049, 057
	Capehart	025, 055, 056, 071
	Carver	015
	CCE	095
	Citizen	006, 007, 087, 088, 089, 090, 095
	Craig	007, 087, 088, 091, 115

	Curtis Mathes	006, 049, 073, 080, 087, 090, 092
	Cybernex	087
<b>D</b>	Daewoo	025, 055, 059, 074, 089, 093, 095, 096
	Daytron	025, 055
	DBX	005, 085
	Dumont	053
	Dynatech	009
<b>E</b>	Electrohome	001, 088, 097
	Electrohome	088
	Emerson	001, 009, 017, 027, 086, 088, 089, 092, 093, 097, 100, 101, 102, 103, 104, 117
<b>F</b>	Fisher	009, 028, 031, 053, 054, 091, 099, 115
<b>G</b>	GE	007, 011, 049, 050, 051, 052, 073, 080, 087
	Go Video	047, 048
	Goldstar	000, 006, 012, 062, 088
	Gradiente	094
	Grundig	042
<b>H</b>	Harley Davidson	094
	Harman Kardon	040, 062
	Hi-Q	091
	Hitachi	009, 013, 023, 026, 058, [108]*, 109, 110, 111
<b>J</b>	JC Penny	004, 005, 007, 023, 028, 049, 062, 085, 087, 088
	Jensen	013, 026
	JVC	004, 005, 006, 026, 029, 043, 044, 045, 046, 085
<b>K</b>	Kenwood	004, 005, 006, 026, 029, 033, 045, 085, 090
	Kodak	088
<b>L</b>	Lloyd	009, 094
	LXI	088
<b>M</b>	Magnavox	015, 016, 042, 049, 063, 106
	Magnin	087
	Marantz	004, 005, 006, 015, 042, 049, 085, 090
	Marta	088
	MEI	049
	Memorex	009, 033, 049, 053, 060, 081, 087, 088, 091, 094, 115
	Metz	123, 124, 125, 126, 127, 128
	MGA	001, 017, 027, 041, 097
	MGN Technology	087
	Midland	011
	Minolta	013, 023
	Mitsubishi	001, 003, 008, 013, 014, 017, 027, 029, 039, 040, 041, 045, 097
	Motorola	081
	Montgomery Ward	001, 002, 007, 009, 049, 063, 081, 115, 117
	MTC	009, 087, 094

	Multitech	007, 009, 011, 087, 090, 094
<b>N</b>	NAD	038
	NEC	004, 005, 006, 018, 026, 029, 045, 061, 062, 085
	Nikko	088
	Noblex	087
<b>O</b>	Optimus	081, 088
	Optonica	021
<b>P</b>	Panasonic	024, 049, 064, 066, 067, 068, 069, 107
	Perdio	009
	Pentax	009, 013, 023, 058, 090
	Philco	015, 016, 049
	Philips	015, 021, 042, 049, 105
	Pilot	088
	Pioneer	005, 013, 029, 036, 037, 038, 045, 085
	Portland	025, 055, 090
	Proscan	063, 080
	Pulsar	060
<b>Q</b>	Quartz	033
	Quasar	034, 035, 049
<b>R</b>	Radio Shack	001, 002, 021, 081, 087, 088, 091, 094, 097, 098, 115
	Radix	088
	Randex	088
	RCA	007, 013, 019, 023, 058, 063, 064, 065, 073, 080, 082, 087, 089, 021, 031, 033, 049, 053, 081, 087, 088, 091, 094, 097, 098
	Realistic	009, 021, 031, 033, 049, 053, 081, 087, 088, 091, 094, 097, 098
	Ricoh	055
<b>S</b>	Salora	033, 041
	Samsung	007, 011, 051, 059, 070, 083, 087, 089, 113
	Sanky	081
	Sansui	005, 026, 029, 045, 061, 085, 114
	Sanyo	032, 033, 053, 087, 091, 115, 116
	SBR	042
	Scott	017, 020, 086, 089, 093, 117
	Sears	013, 023, 028, 031, 033, 053, 054, 088, 091, 098, 099, 115
	Sentra	055
	Sharp	001, 002, 021, 097
	Shogun	087
	Sony	075, 076, 077, 078, 079, 121, 122
	STS	023
	Sylvania	009, 015, 016, 017, 041, 049, 094
	Symphonic	009, 094
<b>T</b>	Tandy	009
	Tashiko	009, 088
	Tatung	004, 026, 030

	Teac	004, 009, 026, 094
	Technics	024, 049
	TMK	087, 092
	Toshiba	013, 017, 020, 041, 059, 089, 098, 099, 117
	Totevision	007, 087, 088
<b>U</b>	Unirech	087
<b>V</b>	Vectror Research	005, 062, 085, 089, 090
	Victor	005, 045, 046, 085
	Video Concepts	005, 027, 085, 089, 090
	Videosonic	007, 087
<b>W</b>	Wards	013, 021, 023, 087, 088, 089, 091, 094, 097, 118, 119, 120
<b>X</b>	XR-1000	094
<b>Y</b>	Yamaha	004, 005, 006, 026, 062, 085
<b>Z</b>	Zenith	060, 078, 079

### Television

<b>A</b>	Admiral	045, 121
	Adventura	122
	Aiko	054
	Akai	016, 027, 046
	Alleron	062
	A-Mark	007
	Amtron	061
	Anam	006, 007, 036
	Anam National	061, 147
	AOC	003, 007, 033, 038, 039, 047, 048, 049, 133
	Archer	007
	Audiovox	007, 061
<b>B</b>	Bauer	155
	Belcor	047
	Bell & Howell	045, 118
	Bradford	061
	Brockwood	003, 047
<b>C</b>	Candle	003, 030, 031, 032, 038, 047, 049, 050, 122
	Capehart	003
	Celebrity	046
	Circuit City	003
	Citizen	029, 030, 031, 032, 034, 038, 047, 049, 050, 054, 061, 095, 122, 123
	Concerto	031, 047, 049
	Colortyme	003, 047, 049, 135
	Contec	013, 051, 052, 061
	Cony	051, 052, 061
	Craig	004, 061
	Crown	029
	Curtis Mathes	029, 034, 038, 044, 047, 049, 053, 095, 118

<b>D</b>	Daewoo	027, 029, 039, 048, 049, 054, 055, 106, 107, 137
	Daytron	003, 049
	Dimensia	044
	Dixi	007, 015, 027
<b>E</b>	Electroband	046
	Electrohome	029, 056, 057, 058, 147
	Elta	027
	Emerson	029, 051, 059, 060, 061, 062, 118, 123, 124, 139, 148
	Envision	038
	Etron	027
<b>F</b>	Fisher	014, 021, 063, 064, 065, 118
	Formenti	155
	Fortress	012
	Fujitsu	004, 062
	Funai	004, 062
	Futuretech	004
<b>G</b>	GE	020, 036, 037, 040, 044, 058, 066, 088, 119, 120, 125, 147
	Goldstar	000, 015, 029, 031, 039, 048, 051, 056, 057, 067, 068, 069, 116
	Grundy	062
<b>H</b>	Hitachi	029, 031, 051, 052, 070, 111, 112, 113, 124, [134]*
	Hitachi Pay TV	151
<b>I</b>	Infinity	017, 071
<b>J</b>	Janeil	122
	JBL	017, 071
	JC Penny	020, 034, 039, 040, 041, 044, 048, 050, 058, 066, 069, 076, 088, 090, 095, 125, 136, 159
	JCB	046
	JVC	019, 051, 052, 072, 073, 091, 117, 126
<b>K</b>	Kawasho	018, 046
	Kenwood	038, 056, 057
	Kloss	010, 032
	Kloss Novabeam	005, 122, 127, 131
	KTV	074, 123
<b>L</b>	Loewe	071
	logik	144
	Luxman	031
	LXI	008, 014, 017, 024, 040, 044, 063, 071, 075, 076, 077, 118, 125
<b>M</b>	Magnavox	005, 010, 017, 030, 033, 038, 050, 056, 071, 078, 079, 085, 089, 108, 109, 110, 127, 131, 132, 145
	Marantz	015, 017, 071, 080
	Matsui	027
	Memorex	014, 027, 045, 083, 118, 144
	Metz	160, 161, 162, 163

MGA	001, 039, 048, 056, 057, 058, 065, 081, 083
Midland	125
Minutz	066
Mitsubishi	001, 016, 039, 048, 056, 057, 058, 065, 081, 082, 083, 105
Montgomery Ward	011, 020, 144, 145, 146
Motorola	121, 147
MTC	031, 034, 039, 048, 095
NAD	008, 075, 076, 128
National	002, 036, 061, 147
National Quenties	002
NEC	031, 038, 039, 048, 057, 084, 086, 135, 147
Nikko	054
NTC	054
Optimus	128
Optonica	011, 012, 093, 121
Orion	004, 139
Panasonic	002, 009, 017, 036, 037, 071, 141, 143, 147
Philco	005, 010, 030, 050, 051, 056, 079, 085, 127, 131, 132, 145, 147
Philips	005, 015, 017, 050, 051, 056, 078, 087, 088, 089, 131, 132, 147
Pioneer	124, 128, 142
Portland	054
Price Club	095
Proscan	040, 044, 125
Proton	035, 051, 092, 129
Pulsar	042
Quasar	036, 037, 074, 141
Radio Shack	011, 044, 063, 093, 118
RCA	040, 044, 125, 130, 137, 151, 152
Realistic	014, 063, 093, 118
Saisho	027
Samsung	003, 015, 034, 053, 055, 057, 094, 095, 136, 153
Sansui	139
Sanyo	013, 014, 021, 022, 063, 064, 081, 096
SBR	015
Schneider	015
Scott	062
Sears	008, 014, 021, 022, 023, 024, 025, 040, 052, 057, 062, 063, 064, 065, 073, 075, 076, 097, 098, 125, 159
Sharp	011, 012, 013, 026, 093, 099, 100, 104, 121
Siemens	013
Signature	045, 144
Simpson	050
Sony	043, 046, 138, 146, 150
Soundesign	030, 050, 062
Spectricon	007, 033

Squareview	004
Supre-Macy	032, 122
Supreme	046
Sylvania	005, 010, 017, 030, 078, 079, 085, 089, 101, 127, 131, 132, 145, 155
Symphonic	004, 148
Tandy	012, 121
Tatung	036, 124
Technics	037
Teknika	001, 030, 032, 034, 052, 054, 078, 083, 095, 144, 156, 157
Tera	035, 129
THOMSON	165, 166
Toshiba	008, 014, 034, 063, 075, 076, 095, 097, 136, 158, 159
Universal	020, 066, 088
Victor	019, 073, 126
Video Concepts	016
Viking	032, 122
Wards	005, 045, 066, 078, 085, 088, 089, 093, 102, 103, 131, 132, 148
Zenith	042, 114, 115, 140, 144, 149
Zonda	007

### Cable

ABC	006, [007]*, 008, 009
Archer	010, 011
Century	011
Citizen	011
Colour Voice	012, 013
Comtronic	014
Eastern	015
Garrard	011
Gemini	030, 033, 034
General Instrument	030, 031, 032
Hytex	006
Jasco	011
Jerrold	009, 016, 017, 026, 032
Magnavox	018
Movie Time	019
NSC	019
Oak	000, 006, 020
Panasonic	001, 005
Philips	011, 012, 013, 018, 021
Pioneer	002, 003, 022
RCA	029
Regency	015
Samsung	014, 023
Scientific Atlanta	004, 024, 025
Signal	014
SL Marx	014
Starcom	009

Stargate	014
Teleview	014
Tocom	007, 016
TV86	019
Unika	011
United Artists	006
Universal	010, 011
Viewstar	018, 019
Zenith	027, 028

### Satellite Receiver

Alphastar	054
Chaparrali	035, 036
Dishnet	053
Drake	037, 038
Echostar Dish	062, 066
GE	048, 055, 056
General Instruments	039, 040, 041
Grundig	070, 071, 072, 073
Hitachi	058, 059
Hughes Networkr	063, 064, 065, 069
JVC	057
Kathrein	074, 075, 076, 083
Magnavoxl	060
Nokia	070, 080, 084, 085, 086
Philips	060
Primestar	051
Proscan	048, 055, 056
RCA	048, 055, 056, 068
Realistic	042
Sierra I	036
Sierra II	036
Sierra III	036
Sony	049, 067
STS1	043
STS2	044
STS3	045
SRS4	046
Technisat	077, 078, 079, 081, 082
Toshiba	047, 050
Uniden	061

### CD Player

Aiwa	001, 035, 043
Burmster	002
Carvery	003, 035
Denon	[111]*, 044
Emerson	004, 005, 006, 007
Fisher	003, 008, 009, 010
JVC	018, 019

Kenwood	011, 012, 013, 014, 017
Magnavox	006, 015, 035
Marantz	016, 028, 035
MCS	016, 024
Onkyo	025, 027
Optimus	017, 020, 021, 022, 023
Philips	014, 032, 033, 035
Pioneer	006, 022, 030
Sears	006
Sony	023, 031
Teac	002, 009, 028
Technics	016, 029, 036
Wards	035, 037
Yamaha	038, 039, 040, 041
Zenith	042

### DVD preset codes / Codes pré-réglés DVD

		111 (default / défaut)	014
DENON Model No. / Modèle numéro	DVD-555	DVD-2900	DVD-800
	DVD-556	DVD-2910	DVD-1600
	DVD-557	DVD-2930CI	DVD-2000
	DVD-558	DVD-3800	DVD-2500
	DVD-755	DVD-3910	DVD-3000
	DVD-756	DVD-3930CI	DVD-3300
	DVD-757	DVD-5900	
	DVD-758	DVD-5910	
	DVD-900	DVD-5910CI	
	DVD-910	DVD-9000	
	DVD-955	DVD-2500BT	
	DVD-1000	DVD-3800BD	
	DVD-1200	DVM-715	
	DVD-1500	DVM-735	
	DVD-1710	DVM-745	
	DVD-1720	DVM-1800	
DVD-1730	DVM-1805		
DVD-1740	DVM-1815		
DVD-1910	DVM-1835		
DVD-1920	DVM-1845		
DVD-1930CI	DVM-2815		
DVD-1940CI	DVM-2845CI		
DVD-2200	DVM-4800		
DVD-2800			
DVD-2800II			

[ ]\*: Preset codes set upon shipment from the factory.  
 : Les codes pré-réglés diffèrent en fonction de la livraison de l'usine.

**DENON**

[www.denon.com](http://www.denon.com)

Denon Brand Company, D&M Holdings Inc.  
Printed in China 5411 10048 004D